

A Contractor's Guide to Installing Interlocking Concrete Pavers

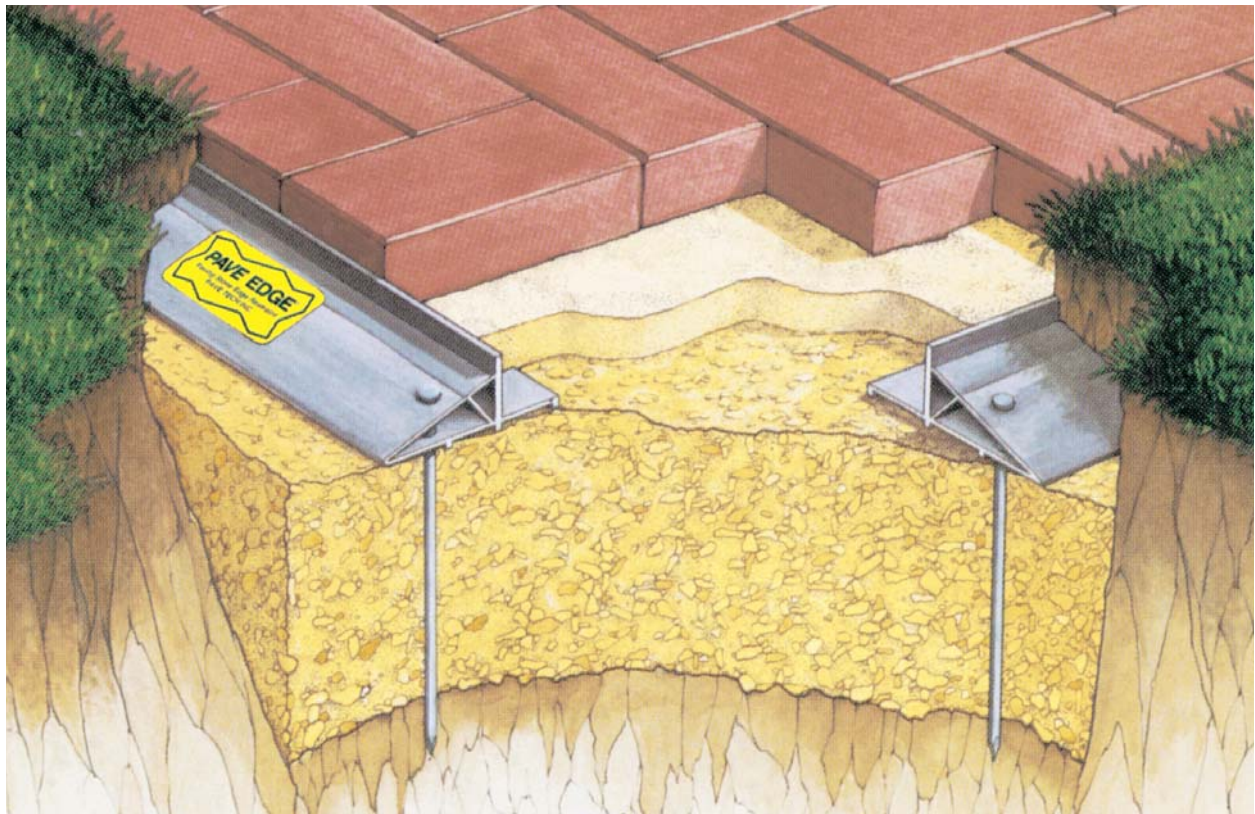

CONCRETE PAVERS ■ LANDSCAPE RETAINING WALLS ■ GARDEN PRODUCTS

INTRODUCTION

Ideal is pleased to offer you this guide to installing interlocking concrete pavers. In compiling it, we drew information from a number of sources. They include the Interlocking Concrete Pavement Institute (ICPI), PAVETECH Inc., UNI-GROUP U.S.A., Vibromax Equipment, and Dr. Brian Shackel, as well as our own experience of working with thousands of architects, engineers, and contractors in the field for over 30 years.

We recognize there are a number of ways to install pavers and that many contractors may have developed their own skills and unique techniques. What we have attempted to do with this guide is to give you some of the best proven practices in the construction of interlocking concrete pavements. We hope that it will help improve your productivity and cost efficiencies while achieving the best quality job possible.

*This guide is intended to give you practical information, time saving tips and 'rules of thumb'. While it covers many aspects of pavement construction, please contact your **Ideal Authorized Dealer** or **Pavers by Ideal**[®] sales representative for comprehensive information on concrete paver installation.*

We value our relationship with our customers, and we seek to bring you innovative ideas and products that create income opportunities. We pride ourselves on our level of experience and the technical support we provide. Our active participation in industry organizations allows us to bring you the latest information and technology. We strive to offer the quality of service that meets your needs. We support you with the help you need...including design consultation, specification assistance, sales promotion, job site training, and quality review...to help make your project a success.

We welcome your comments and guidance to help us better serve your needs and growth.

©1996-2006 Ideal Concrete Block Company, Inc.



A Registered Trademark of Ideal Concrete Block Company, Inc.

45 Power Road, Westford, MA 01886
232 Lexington Street, Waltham, MA 02452
(781) 894-3200 • Westford Fax (978) 692-0817 • Waltham Fax (781) 894-8526
www.IdealConcreteBlock.com

TABLE OF CONTENTS

Interlocking Concrete Pavement Basics	1	What to Use.....	12
Getting Started	1	Starting Laying Patterns.....	12
The Real Beginning	2	Selecting Pavers.....	13
Selling the Customer.....	2	Placing the Pavers.....	13
Sell Yourself.....	2	The 'Pyramid'.....	13
Sell the Benefits of and Interlocking Concrete Pavement.....	2	Openings.....	14
Sell the Project.....	2	Curves and Changing Direction.....	14
Sell the Styles.....	2	Soldiers and Sailors.....	14
Sell the Colors with Style™.....	2	Cutting Pavers.....	15
Sell the Finishes.....	3	Compacting Pavers.....	16
Sell the Shapes and Patterns.....	3	SandLock™.....	16
Sell the Paver Thickness.....	3	Finishing	17
A Word of Advice.....	3	Congratulations.....	17
Sell the Quality Assurance of Ideal.....	3	Pavers by Ideal® Warranty.....	17
Sell the Assurance of Ideal's Warranty.....	4	Costing - Did You Make Money?.....	17
Estimating	4	More Info You Need to Know	18
Estimating - From the Bottom Up.....	4	Pavement Repairs.....	18
Measure the Area to be Paved.....	4	Cleaning and Sealing.....	18
Estimating - Excavation.....	4	A Word About Efflorescence.....	18
Subgrade Soil - Mother Nature's Gift.....	4	Specialty Products	19
Help - It's Clay!.....	4	Eco-Stone® Permeable Pavers	19
Estimating - Determining the Depth of Excavation.....	4	Eco-Stone® Construction.....	19
Estimating - Determining the Amount of Excavation.....	5	Design Guidelines.....	19
Estimating - Calculating the Volume of Soil to be Removed.....	5	Maintenance.....	20
Estimating - Base Thickness.....	5	Turfstone™ Grid Pavers	20
Base Material - Types.....	5	BullNose Coping	20
Base Material - Calculating the Quantity.....	5	Mechanical Installation	21
Estimating - Bedding and Joint Sand.....	5	Alternate Setting Methods	21
Estimating - SandLock™.....	6	Mortar Set.....	21
Estimating - Edging.....	6	Asphalt Set.....	21
Estimating - Pavers.....	6	Special Conditions	21
Estimating - Cutting.....	7	Soil Cement or Rehabilitating the Base.....	21
The Contract - Submitting Your Price.....	7	A Construction Checklist	22
You've Signed the Deal - Placing the Order.....	7	Question & Answer Section	23
Delivery.....	7	Reference Section	25
Performing the Work	8	ASTM Gradations for Bedding and Joint Sand.....	25
Safety and First Aid.....	8	ASTM Gradations for Base Materials.....	25
Planning.....	8	ICPI Interlocking Concrete Pavement Tolerances.....	26
Your Crew.....	8	Tools and Equipment.....	27
Excavation	8	Formulas, Weights and Measures.....	27
Slope and Pitch.....	8	Glossary of Terms.....	28
Base Installation - Compaction	8	Patterns with Style™.....	31
Type of Material.....	9	ICPI Zaphers Pavement Cross Sections.....	36
Moisture Content.....	9	Notes.....	42
Compaction Equipment.....	9		
Compaction Process.....	9		
Measuring Soil Compaction.....	10		
Edge Restraints	10		
Bedding Sand	10		
Screeding.....	10		
Paver Installation	11		
Delivery and Handling.....	11		
The Layout.....	11		
Holding Straight Lines.....	12		
Laying Patterns.....	12		
Circles and Fans.....	12		

INTERLOCKING CONCRETE PAVEMENT BASICS

Before we get started, we thought it might be helpful to review some of the basic information about concrete pavers and why they work so well as a pavement. Some people tend to think of concrete pavers as being relatively new, but in truth, they have been used in pavements in Europe since the early 1950s. You might even say that concrete pavers have been "field tested" for over 50 years!

In the mid 1970s, *Ideal* became one of the first companies in the United States to produce concrete pavers. While we had extensive experience in manufacturing structural concrete products since 1923, we developed special mix designs to produce the high strengths required for pavers. Our production facility utilizes special equipment designed to make high density, concrete products. Strict quality control ensures consistent strength, color, and size. We constantly strive to improve our products. You can feel confident using our products, knowing that we have over 80 years of experience and offer the finest quality pavers and wall systems available. In fact, nobody does it better!

Our concrete pavers are very dense, accurate in size, and possess a slip-resistant finish. They have an average compressive strength that consistently ranges between 9,000 and 11,000 psi. When you consider that poured and patterned concrete are about 3,000 to 4,000 psi and that most clay brick are 5,000 to 6,000 psi, you can see our pavers are considerably stronger than asphalt, regular concrete, and most clay brick. Freeze-thaw resistant? You bet! They've stood the test of time, including the rigorous Canadian freeze-thaw test procedure.

Our concrete pavers are very uniform in size and fit tightly together when placed into the desired laying pattern. The sand-filled joints cause the pavers to "lock up" like the pieces of a puzzle. It is why we say that all of our concrete pavers are considered "interlocking" regardless of the shape. And it is the reason why concrete pavers are designed to work best when set in sand.

Pavements constructed of interlocking concrete pavers set on sand over a flexible granular base are often known as "segmental pavements".

Components of Segmental Pavements:

1. High-strength concrete pavers
2. Sand setting bed
3. Edge restraint
4. Compacted base material
5. Subgrade or existing soil

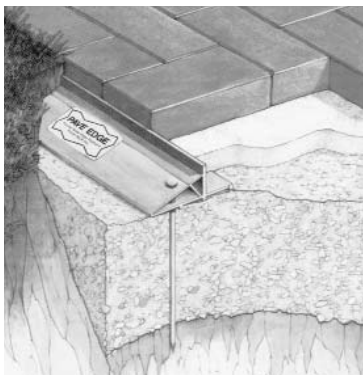

Segmented pavements are:

Flexible - They can expand and contract without cracking.

Strong & Dense - They have the durability to withstand New England's harsh climate.

Practical - They can accommodate any type of traffic without cracking under heavy loads.

Snow Plow Safe - Shovels, snow blowers, and conventional snow plowing equipment pose no problem for properly installed pavers.

Versatile - They can be used for walks, patios, and pool decks, driveways, streets... even heavy-duty industrial projects!

Easy to Maintain - They are unaffected by oil and gas spills. When repairs are necessary, they can be lifted and reinstated without leaving an unsightly permanent "patch" as with conventional paving materials.

Economical - All things considered, interlocking concrete pavements have the lowest life-cycle costs!



GETTING STARTED

We have listed some of the steps involved in an installation of interlocking concrete pavers. This Guide follows them in the order listed below.

- **Selling yourself and the project**
 - Earn the customer's confidence in you and the project
 - Select the paver type, shape, color, and laying pattern
- **Estimate the cost of the project**
 - Measure the area to be paved
 - Determine the base thickness
 - Check soil conditions
 - Calculate amount of soil to be excavated
 - Calculate quantity of:
 - Base material
 - Sand
 - Edging
 - Pavers
- **Obtain signed contract**
- **Scheduling**
 - Place order for pavers
 - Schedule delivery of all materials and equipment
- **Installation**
 - Prepare the area by excavating soil and installing the base
 - Install the pavers
- **Job clean up and finish**

THE REAL BEGINNING

Selling the Customer!

Perhaps you have been asked to give a prospect - a potential customer - a price for a paver walkway, patio, driveway, or pool deck. Most likely they have done some research and have a pretty good idea of what they want. However, don't assume that they are convinced that concrete pavers are the way to go or that you are the contractor they want to have do the work!

This is the time when salesmanship is important. And while some people are born salesman, selling is a process that anyone can follow. Here are some useful tips to make the sale!

Sell Yourself - Tell them about your company!

Even if you were referred to them by your **Ideal Authorized Dealer** or another customer, it is important to establish your credentials and credibility face-to-face. In our **Come Home to Style** catalog, we have detailed some of the essential business aspects and performance qualifications that a contractor who installs pavers should offer. If you have developed a portfolio of projects you've completed, review it with them. Let them know if you provide design assistance. It's a valuable service! Be sure to show them those letters of recommendation or testimonials from satisfied customers. You do have them...don't you?

Sell the Benefits of an Interlocking Concrete Pavement - A wise investment!

Bear in mind that this is a big decision for them. An interlocking concrete pavement is an investment that will provide returns by increasing the equity in their home. Landscaping has proven to provide a return on investment of 100-200%, and can increase a home's value by as much as 20%! But, like any investment, it involves a capital outlay... money that could be spent elsewhere. So



show them our **Come Home to Style** catalog. It is filled with great images, ideas, and projects that will help them visualize how their home can be transformed with a picturesque pavement or landscape retaining wall, that will provide years of lasting beauty. Review the Comparison Charts located in our **Come Home to Style** catalog. They provide useful information by comparing the important aspects of concrete pavers to all other types of popular paving materials that the customer may be considering. We have even included a **Q&A Section** of the most common questions about pavers that we have been asked over the years. It goes a long way in answering some of the concerns they may have about using pavers.

Let your prospective customers see how our products - and your skills - can make their home beautiful and inviting to family, friends, and neighbors for years to come with our **Come Home to Style** catalog!

Sell the Project

Suggest that they spend time thinking about where they would like their new pavement situated in relation to their home and topography of their property. Do they want you to create a new pathway to the front entry or into the backyard...or are they looking to create a new outdoor living space for relaxation and entertaining? Help them visualize foot traffic patterns and how the pavement will define and maximize their landscape. If they simply wish to replace an existing pavement, have them consider whether the width needs to be increased...or would they like you to change the form and shape to be more functional? Invest a little time with them...it will go a long way!

Sell the Styles - You have lots to choose from!

Pavers by Ideal® features a wide range of colors, styles, sizes, and shapes that give you and your customers real choices. Our pavers create engaging designs and patterns that no other paving material can match! Have your customers select from our many traditional shapes for classic, time-honored pavements, or from our attractive contemporary styles. Our **Come Home to Style** catalog shows the many styles of pavers we offer and the eye-catching pavements they create. Provide your customers with a copy...it will make closing sales easier than ever before! And remember, your customer will rely on you for advice. Some colors and styles may require lead time, so if they want the project done quickly, be sure to know what styles are available from your **Ideal Authorized Dealer**. You might even want to discuss second choices. This way, you'll be ready when they are!

Sell the Colors with Style! - Our beauty is more than skin deep!

Color...is the number one reason why more discriminating homeowners, architects, and design professionals choose our pavers over other types of paving materials! We make them in a wide range of beautiful colors inspired by the deep, rich hues authentic to New England's architecture and landscapes. Our Drum-Roll Tumbled™ collection of pavers features the soft patina of weathered tones in time-honored colors. We color our pavers - and walls - with the highest quality pigments and saturate them "throughout the body" - not just at the surface. So if a chip happens to occur, it will be hardly discernable.

The **Colors with Style**™ section of our **Come Home to Style** catalog offers a pretty good idea of what colors we offer. Start there, but *be sure to have your customers make their final selection from actual samples*. Pavers are made using natural materials, so when showing them color samples, let them know that the product they receive may vary somewhat in color and texture from the samples. Having them think of it as dye-lots, similar to paint or fabric, may help them better understand.



Tip: Offer to create a unique blend just for them by intermixing two or more colors at the job site. The possibilities are endless! If using a soldier course, consider an accent color that contrasts the color chosen for the field of the pavement.

**Rule of Thumb:**

Show your customers no less than 5 full pavers as samples when selecting colors.

Sell the Finishes - Traditional or tumbled?

Our traditional finishes offer a refined surface with a slip-resistant texture. Most shapes are made with distinctive chamfers, while others, like our Yankee Cobble™, have an embossed surface and pressed corners. If the colors, texture, and durability of vintage stone pavements suits your customer, our Drum-Roll Tumbled™ collection of pavers faithfully reproduce the authentic look of natural stone. For a more rustic appearance, install both the chamfered and square edge sides of our Georgetown Colonial Paver™ facing upward in a random fashion.



Traditional Paver Style
Boston Colonial Paver®



Drum-Roll Tumbled™ Style
Georgetown Colonial Paver™

Sell the Shapes and Patterns - Getting creative!

In most cases, shape is a matter of preference as to its appearance and the laying patterns it can make. Most shapes can be installed in a variety of laying patterns. Choose from classic 45° or 90° herringbones, traditional running bonds, elegant basket weaves, circles, fans, or sweeping curves. Some pavers, such as Symetry®, have shapes that lend themselves to patterns specific to their geometry. Other styles can be installed in virtually unlimited patterns and combinations.



Symetry® with
Symetry® Squares

Any pattern is suitable for walkways, patios, or pool decks. Running bond and basket weaves can be used for residential driveways, however, herringbone patterns provide the greatest degree of interlock. *Stack bond patterns should only be used for pedestrian applications.*



Tip: If the pavement has drastic changes in direction, try to pick a shape that accommodates curves with a minimum of cutting.

Sell the Paver Thickness - 6 cm or 8 cm?

Most of the pavers we offer are 6 cm (2 3/8") thick. Some are made 8 cm (3 1/8") thick to accommodate heavy traffic and load requirements. Our 6 cm pavers should serve all of your needs for residential applications.

**Rule of Thumb:**

Use 6 cm pavers for all residential applications and 8 cm for street, industrial, and port uses.

A Word of Advice - Don't over sell the product!

Concrete pavers are one of the strongest and most durable paving materials available. While they are very uniform in size and most possess distinct chamfers, they are not tile, and the texture of the surface is not intended to have a consistently smooth finish. It is not unusual to see marks, small stones, or even minor cracks. After all, concrete pavers are made of natural ingredients. (Of course, people love the chips, scratches, and worn edges of our Drum-Roll Tumbled™ pavers.)

It is interesting to note that the clay brick industry allows every paving brick to contain chips as large as 5/16" along the edge and 1/2" at the corners! Although the concrete paver industry under ASTM specification C-936 simply states that minor cracks and chips shall not be deemed grounds for rejection, we have often used the size of a dime to measure acceptable character marks.

Discuss this with your customer. Let them know that some size, color, and texture variations are normal in products made with natural ingredients. Don't shy away from discussing the possibility of efflorescence. It also is natural and may appear without warning (see page 18 for more information).

An educated customer is a good customer. They should feel good about their decision to use concrete pavers, and these types of discussions will go a long way towards making the sale and avoiding potential problems and misunderstandings.

**Sell the Quality Assurance of Ideal...a name they can rely on!**

Pavers by Ideal® is a registered trademark of **Ideal Concrete Block Company, Inc.**, a name synonymous with quality concrete masonry products. We have made New England our home for a while...since 1923 to be exact! And during that time, the **Ideal** tradition for quality has been passed along to three generations of the Burgoyne family. We manufacture one of the largest selections of interlocking concrete pavers, dry-stack retaining wall systems, and concrete masonry yardscape products in the Northeast. **You can rely on us...**our name stands for quality, service, and reliability...over 80 years worth!

Sell the Assurance of Ideal's Warranty

Ideal provides a lifetime warranty on the structural integrity of our pavers used in residential applications. Material installed according to our guidelines that proves to be defective will be replaced without cost. Color matching cannot be guaranteed and replacement labor is not included. Proof of purchase is required and other exclusions apply. Please ask for complete details.

ESTIMATING

Estimating - *From the bottom up!*

In this section, we'll look at how to properly estimate materials to ensure that you are covering your material costs and properly allocating labor costs.

Bear in mind that an estimate is just that - an estimate. It is not intended to determine the exact amount of materials, right down to the final paver. But a good estimate will guide you in ordering enough materials, without wasting time and money by going overboard. More importantly, it will help give you a pretty good idea of how many man-hours it will take to do the job. With this information, you will be able to factor in your overhead for your direct costs for labor, materials, and equipment so that you can realize the profit due to you!

- Excavation • Base material • Sand • Cutting • Pavers

Measure the Area to be Paved

It is always best to measure the actual area to be paved. By visiting the site, you can familiarize yourself with access to it and note existing structures that could affect the installation. If working from a set of plans, always double check the drawings, scale, and details. To help determine the square footage of the area, you may wish to use one of the formulas we have provided in the **Reference Section**.

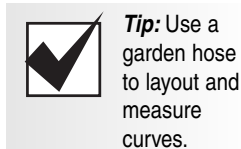

Estimating - *Excavation*

In order to calculate how deep to excavate, you need to know how thick the base should be. There are a number of factors that are explained under **Estimating - Base Thickness** section. For now though, it is important to know the type of subgrade soil the base will be sitting on.

Subgrade Soil - *Mother Nature's Gift*

The subgrade is the soil that is native to the site. And unless the site was excavated and later filled during construction, most likely the soil has existed there for thousands of years. The type of soil found in the subgrade influences a pavement's ability to support loads. Weak subgrade soil can deform, causing base material to settle or rut over time. Knowing what type of soil is at the site is important.

Soil Types - Soils are divided into three groups:

- Granular - Sand and gravel consisting of grains down to .002 inch
- Clay - Very fine scale-shaped particles

- Organic - Loam, peat that is made up of moss, leaves, and vegetable matter, and top soil

If you have granular soil, such as gravel, you're in great shape. Granular soils are best for drainage and strength. On the other hand, clay soils are weak and while quite dense, they do not provide sufficient strength to support loads. They will require a thicker base to avoid deformation in the pavement. Organic soil, such as peat and loam, should be removed. How do you tell? On commercial projects, soil borings are taken to determine the type. On small projects, dig a few holes with a shovel. Pick up a handful of soil, rub it between your fingers and match it against the chart below. Granular soil feels gritty. If the soil feels slick, especially when wet, most likely it is comprised of clay.

Quick Soil-Typing Guide from Vibromax Equipment

What to look for	Granular soils, fine sands, silts	Plastic (cohesive) soils, clay
Visual appearance and feel	Coarse grains can be seen; feels gritty when rubbed between fingers.	Grains cannot be seen by naked eye; feels smooth & greasy when rubbed between fingers.
Movement of water in the spaces	When a small quantity is shaken in the palm of the hand, water will appear on the surface of the sample. When shaking is stopped, water gradually disappears.	When a small quantity is shaken in the palm of the hand, it shows no sign of water moving out of the voids.
Plasticity when moist	Very little or no plasticity.	Plastic & sticky; can be rolled.
Cohesion in dry state	Little or no cohesive strength in dry state; will crumble readily.	Has a high dried strength; crumbles with difficulty & disintegrates slowly in water.

Help - *It's Clay!*

If the subgrade is comprised of clay or silty soils, you will need to increase the thickness of the base and should place woven geotextile fabric, such as SRW SS5, on top of the subgrade soil. Clay is a cohesive, or sticky soil, and takes longer to compact than granular soil, so you should also account for the additional time it will take. On large projects, you may want to rent a "rammer" type compactor. It works faster in rearranging the slick particles found in clay than a plate or vibratory compactor. *Loam, peat and organic soil must be removed!*

Estimating - *Determining the Depth of Excavation*

The depth of excavation will depend upon your project and soil conditions. The chart below will give you an idea of how deep you need to dig when using 6 cm (2 3/8") thick pavers over a 1" thick sand setting bed. If you have good draining soil, such as gravel, you can use the minimum thickness shown as a guide. For poor soils, such as clay, use the greater depth.

Project	Depth of Excavation		Thickness of Base	
	Good Draining Soil	Poor Draining Soil	Good Draining Soil	Poor Draining Soil
Walkway & Patio	7"	9"	4"	6"
Pool Deck	9"	11"	6"	8"
Driveway	11"	15"	8"	12"



Tip: Because pool installations involve a lot of excavation, a large volume of earth is disturbed. Unless you are confident that the soil has been back-filled and compacted in lifts, it may be advisable to wait 6 months or longer for the soil around the pool to settle naturally.

Estimating - Determining the Amount of Excavation

1. Determine the total area to be excavated from your site measurements. If using an edging other than a building or in-place curb, add a dimension equal to the thickness of the base.



Rule of Thumb:

Add 6" to the dimensions of all sides of the paved area when using PaveEdge® edging.

2. Determine how thick the base should be for the project. See the **Estimating - Base Thickness** section for rule of thumb guidelines.

3. Calculate the total excavation depth with this formula:

- Subbase (if any): _____ inches
- Base (compacted): _____ inches
- Sand bedding: _____ inches
- Paver thickness: _____ inches
- **Total of above:** _____ **inches**

To allow for sand compaction and settling during pavement "lock-up," subtract 1/2" from this total for your final excavation depth.

Estimating - Calculating the Volume of Soil to be Removed

When soil is excavated, it gains air and swells approximately 10% in volume when moved and dumped. Consider this when calculating how many loads you will need to transport if you intend to truck it from the site. For example, if there are 10 cubic yards of soil to be excavated, it will require 11 cubic yards of dump truck space.

To calculate the number of truck loads to be removed, use the following formula:

- Volume of soil excavated = Sf area x depth ÷ by 27 = cubic yards (3200 lb)
- Swelled volume of soil = Cubic yards x 1.1
- Tons to be removed = Swelled volume x 1.6

Estimating - Base Thickness

As previously mentioned, the thickness of the base is determined by a number of factors: how the pavement will be used, the type of traffic loads it will receive, drainage conditions on the site, the type of subgrade soil, and climate. In the Northeast, our freezing conditions require a more substantial base than what Southern climates require. See the following rule of thumb for guidance.



Rule of Thumb:

The minimum base thickness over well-drained soils, after compaction, is:

- 4" - 6" for residential walks and patios
- 6" - 8" for pool decks
- 8" - 12" for residential driveways
- 12"+ for parking lots and residential streets

Base Material - Types

Interlocking pavements are typically built as flexible pavements on a compacted granular aggregate, similar to the material used for asphalt pavements. While the gravel may vary regionally, most pits have a type suitable for road construction. If unsure, ask for material that meets your state's highway spec. For instance, Massachusetts has MA Highway Spec M 2.01.7 for Crushed Stone or M 1.03.1 for Processed Gravel. Asphalt, concrete, and flowable fill also may be used as base material.



Rule of Thumb:

Use granular material such as 1 1/2" processed gravel or 3/4" crusher run, sometimes called dense graded, for base material.

Base Material - Calculating the Quantity

Base material is estimated by the cubic yard and bought by the ton. Be sure to account for the consolidation of the base material when it is compacted.



Rule of Thumb:

For every 100 sf of base area, you need the following tons of material for the thickness shown:

- 4" thick = 2 tons
- 6" thick = 3 tons
- 8" thick = 4 tons
- 12" thick = 6 tons



Tip: Did you remember to include the amount of base material for the 6" dimension around all of the sides of the area if you're using PaveEdge®?

Estimating - Bedding and Joint Sand

The sand used for bedding and jointing should be clean concrete sand, free of clay, dirt, or foreign matter and should conform to ASTM C-33. Masonry sand, conforming to ASTM C-144, can be used to complete the filling of the joints after the initial compaction and sweeping with concrete sand. **We do not recommend the use of stone dust!!!** If you prefer this type of material, use coarse stone sand. (Note: Eco-Stone® pavements require a specially-graded aggregate for the setting bed and joint/void filler. See page 19 for more information on Eco-Stone and the proper aggregate it uses.) Bedding sand should be spread to a uniform thickness 1" deep. **It should not be thicker than 1 1/2".**



Rule of Thumb:

Use concrete sand conforming to ASTM C-33 for the bedding layer.



Rule of Thumb:

For every 125 sf of pavers, approximately 1 ton of sand is required for bedding and jointing when screeding the sand 1" thick.

Estimating - SandLock™

SandLock™ is a non-toxic, organic sand binder that seals the joints of interlocking concrete pavement. **SandLock™** forms a natural glue that bonds the sand particles together when activated by water. Sand erosion from wind, traffic, and rain is greatly reduced. It helps prevent weeds from wind-blown germination and is highly effective against ants. **SandLock™** remains flexible and accommodates thermal movement without cracking. *Still not sure about using it? Think of the time and money you will save by not having to send men back to the job to re-sweep because your customer has called you back!*



Rule of Thumb:

Sandlock™ Premix: 50 sf per 50 lb bag.
Sandlock™ Concentrate: 2 lb mixed with 100 lb sand (9 to 11 shovelfuls) per 100 sf.
Coverage rates will vary with the shape, thickness, and width of joints.

Estimating - Edging

Pavers *must* be restrained around the perimeter of the pavement to prevent spreading apart and rutting...even for walkways! It is important to know that pavers will receive their heaviest (and most disruptive) loads when you run the compactor along the edge during installation! **Sod or turf is simply not sufficient to hold the pavers in place!**

Selecting the right type of edging is important. Inferior edging may shift during the compaction process and will likely continue to move over time, resulting in loss of pavement interlock and causing the pavers to spread apart, settle, and twist. There are four general types of edge restraints:

- Manufactured - **PaveEdge®**, steel, or aluminum
- **CurbStone™**, precast and granite curbing
- Cast on-site - poured-in-place concrete, troweled concrete
- Existing walls, segmental retaining walls, or other pavements also can serve as edge restraints



Rule of Thumb:

Do not use plastic edging that is intended for bordering gardens and planting beds!

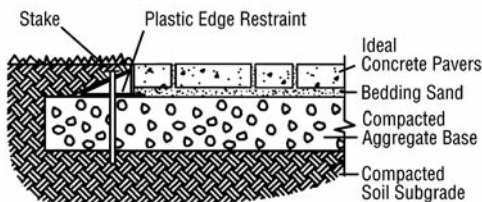

Manufactured Edging - We recommend **PaveEdge®**

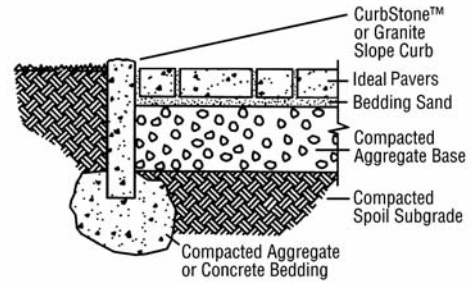

CurbStone™, Granite Slope Curbing or Cobble Edging

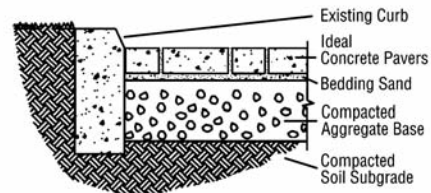

Existing Edging

Manufactured edging is set directly on the base after it has been compacted. Properly installed, it is hidden from view and allows grass to grow directly against the edge of the pavement, if desired. While various types of edging materials can be used, we recommend **PaveEdge® RIGID** or **FLEX**. Few other edge restraints can match its performance and it is the only product with a patented frost lip that repositions the edging back into place should heaving occur. It is easy to install and will not rot or rust. **PaveEdge®** is placed directly on the compacted base and is secured in place by driving 10" spikes into the pre-drilled holes.

Granite, precast curbs, and **Ideal's CurbStone™** are set prior to installing the base and are typically placed in a concrete bedding or backfill. They should extend below the sand bedding layer and should have geotextile fabric placed along the inside edge to prevent sand loss through the joints between pieces.



Troweled concrete, mixed to a stiff consistency, is placed after the pavers have been installed. Though it may be economical to use, troweled concrete may eventually crack due to the freeze-thaw cycles of New England's climate. If it does, it may not be able to resist lateral pressure and can lead to failure in the pavement along the edge.

Estimating - Pavers

Refer to our **Color and Product Packaging Directory** to determine how many pavers are required per square foot of pavement. It provides useful information on each style such as:

- The number of pieces per square foot
- The weight per square foot
- The number of pieces per cube
- The number of square feet per cube
- The weight per cube



Tip: Be sure to get a new **Color and Product Packaging Directory** each year from your **Ideal Authorized Dealer** to ensure current product information and color availability.

Estimating - Cutting

Determine the lineal feet of cutting that will be required for the project. The amount of pavers to be cut is determined by the dimensions of the pavement and its shape. If possible, vary the dimensions to maximize the use of full stones. Site features in the pavement such as trees, benches, manholes, etc., also affect cutting. **Even shapes that offer factory-made edge stones will likely require cutting.**



Tip: To account for cutting and waste, add 3% to the amount of pavers needed to cover the area. If the layout involves a lot of cutting, it's best to allow 5%. Narrow pavements, such as serpentine walks, will require an amount as high as 15%.



Rule of Thumb:

Typical productivity rates for cutting is 25-30 lf of pavers per hour using a power saw with a diamond blade.

The Contract - Submitting Your Price

Once you have looked at the scope of the work, priced the materials and equipment costs, determined the amount of labor hours it will take to complete the project, and assigned your overhead and profit margins, it's time to submit your price. A written proposal is best as it spells out the scope of the work and eliminates confusion. If your proposal serves as a contract document, be sure it includes the start and completion dates, an itemized list of the work to be performed, taxes, and payment terms. If you guarantee your work, list the length of time.

You've Signed the Deal - Placing the order!

Congratulations...you're half-way there! You've converted a prospect to a customer. Now it's time to review their selection one more time. Finalize the paver style, shape, color, texture, and laying pattern from physical samples. You may want to draw up a simple sketch showing the new pavement in relation to the house and property lines. Show their house to scale within the property and note existing structures such as sheds, fences, and other paved areas. Include trees, shrubs, or plantings. If you have a computer, you might want to consider using landscape software. Use stakes and strings or a garden hose to layout the pavement boundaries and help your customer visualize how it will look in relation to



the house and site amenities. Once you have finalized the design, measure the dimensions carefully and commit them to paper. Next, it's time to contact your **Ideal Authorized Dealer** to place the order. Don't wait - give them as much lead time as possible. There are times when several weeks may be required to fulfill orders due to manufacturing schedules. Therefore, it's best to place your orders as far in advance as possible prior to starting the job. Don't wait until the 11th hour!

Okay, here's some helpful information your **Ideal Authorized Dealer** will need:

1. Your name, company name, address, and phone number.
2. A phone number on the site.
3. Square footage of each paver style, size, and color.
4. Lineal feet of edging and if using border stones, such as **Ideal's CurbStone™**, include them as well.
5. Delivery instructions. Tell them when and where you want the pavers delivered, and include your customer's name, address, and phone number. Offer directions to the site, and be sure to tell your supplier about site conditions or hazards that might affect access.
6. If you are not going to be there when the shipment arrives, tell them where you want the material placed, including sand and base material.
7. Sign and keep any delivery receipts whenever possible.

When placing your order, provide your **Authorized Dealer** with the entire amount of pavers that will be required for your project. The actual quantity may be adjusted to comply with packaging requirements. Generally, this means rounding up to full sections, or straps, if your order does not consist entirely of full cubes.



Rule of Thumb:

If your project requires more than one truckload of material, always try to arrange delivery or pick up of product from the same manufacturing run to minimize potential color, size, or texture variations.

The pavers will be shipped on wood pallets. Some shapes, such as our Yankee Cobble™ Circle Pak, are shipped on production pallets, and our Millstone™ Circle Pak is shipped in crates - all are more expensive than regular pallets. Be sure to check with your **Ideal Authorized Dealer** to see how they handle pallet returns. Often, the charge may be credited if they are returned in reusable condition. Always ask about other terms and conditions of sale that may apply.

Delivery

Your **Ideal Authorized Dealer** may offer delivery in 10-wheeler or trailer-size loads. Typically, 10-wheelers carry about 12 cubes of pavers and trailers as many as 22 cubes. Many of our **Dealers** offer spyder unloading which enables them to place the materials as close as possible to the work area, saving time and money. Check with them to see what type of truck your order will be sent on. Some areas of New England impose weight restrictions, so actual quantities may vary. Your **Ideal Authorized Dealer** will be able to determine how many cubes they can ship on one truck.

PERFORMING THE WORK

SAFETY - Rule # 1!!!

Good construction practices include employing good safety measures. Mark the work area with caution tape to alert others that work is being performed. Secure the area whenever you leave to prevent accidents. Insist that safety goggles be worn to protect eyes during saw cutting, chiseling, and while splitting pavers. Wearing an apron is a good idea when using a wet-cut masonry saw. Ear protection and/or a NIOSH-approved respirator also should be worn when operating a saw, compaction machinery, or when working around other loud equipment. A fully-stocked first aid kit is the most important tool you should carry! And don't forget water, especially on hot summer days. Drinking plenty of water is important to avoiding heat stress, which can lead to more serious health problems.

PLANNING - Avoid downtime!

Planning is essential to completing a quality job as quickly as possible. Scheduling delivery of materials to the site and deciding where they should be placed are important to completing the project efficiently and profitably. Take delivery prior to starting the work, and whenever possible, try to have the materials placed in strategic areas that avoid re-handling or moving them any distance to the work area. Most experienced contractors use paver carts to move pavers to the laying edge more effectively. If other trades are involved in the project, be sure to coordinate your schedule with their work.

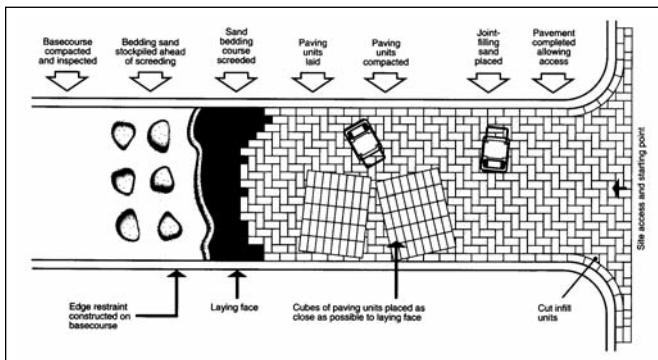

Efficient work site materials placement

Your Crew - Rowing in rhythm!

Your resources on the job are your workers, equipment, and materials. Efficiently managing all three will lead to finishing the job on time, on budget, and with the utmost quality. Make sure each member of your crew understands his job. Concrete paver installations involve a number of tasks, some of which may be going on simultaneously. Everyone on the crew should know the tasks they are expected to perform. Your foreman should tell everyone what is expected of them, and at the start of every work day, inform them what you want to get accomplished on the project for that day. The foreman also must keep the workers balanced among the various tasks to ensure a productive flow of labor moving around the job site. The foreman should complete time and material sheets at the end of every day to accurately track the crew's progress and costs.



Rule of Thumb:

Your crew should be as productive as possible when performing the work to keep the costs at the level you have estimated for the project.

EXCAVATION

It is always a good idea to stake out the area and mark the perimeter with string lines or spray paint. Look for sprinkler heads and buried cables.



Rule of Thumb:

Before you excavate, contact your local utility companies, such as Dig Safe or Call Before You Dig, and request they mark all underground cables and pipes. Give them at least one week's notice!

Slope and Pitch - Obeying the law of gravity!

The pavement should be sloped away from buildings for drainage. Walks also should be sloped to remove rain and snow. Do not, however, slope the base by decreasing its thickness! Instead, create a slope by grading the existing subgrade soil during excavation. The grade should reflect the slope and elevation of the finished pavement. Excavate to the proper depth for the job then compact the subgrade thoroughly. If using a woven geotextile fabric, roll it out so the subgrade is fully covered. Overlap all seams by about 24" and extend it up the sides of the excavated area.



Rule of Thumb:

The minimum slope in the soil subgrade is a 1" drop for every 5' or about 1 1/2%.

BASE INSTALLATION - Compaction, compaction, and more compaction!

Base installation is critical to a successful paver installation. If the base is not compacted properly, the pavement will settle over time, and rutting and deformation may occur. Pavers can even chip and crack as a result of improper compaction, so it's important to do it correctly. If another contractor is responsible for excavation and base installation, play it safe and make sure their work meets project specifications and allowable tolerances prior to beginning your work. Do not set pavers on a base that is not properly compacted or is not graded to the required slope and depth specifications.



Rule of Thumb:

For walks and residential driveways, the base should be compacted to no less than 98% standard Proctor density. For streets and commercial driveways, compaction should be no less than 98% modified Proctor density.

Compaction is the process of pushing the soil particles closer together by squeezing out the air and moisture to increase the density of the soil. Three factors affect compaction:

1. The type of soil
2. The moisture content of the soil
3. The type of compacting effort required
- pressing, ramming, or vibration

Type of Material

If you have purchased the proper base aggregate, it will contain a gradation of particles that will pack tightly together when compacted.

Moisture Content

Soils compact easier and better when they contain the right amount of moisture. Here is a quick and simple field test:

- Squeeze a handful of the base material into the size of a tennis ball.
- If it holds its shape for the most part when you open your hand, the soil probably has an adequate amount of moisture. Otherwise, you will need to add water to bring it to its optimum moisture content.



Tip: Soak, but do not saturate, each layer of base material before you compact it.

Compaction Equipment

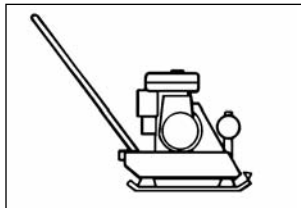
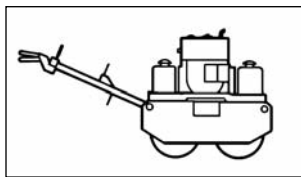

Plate Compactor

To achieve good compaction, you must use the type of machine that provides the proper force, amplitude, and frequency. Use plate compactors that run between 75 to 90 hertz and apply a 4,000 to 5,000 lb centrifugal force.



Vibratory Roller

Always follow the equipment manufacturer's recommendations with regards to the proper running speed for the machine you are using. And remember, compactors are heavy, so use caution when lifting them off and onto your truck! Frozen base material should not be compacted, nor should material be placed over a frozen soil subgrade.

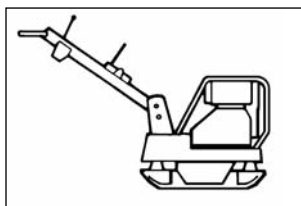

Plate Rammer



Tip: Use a 4000-5000 lb plate compactor for walks, patios, and pool decks. For driveways, use a walk-behind vibratory roller or plate rammer.

Compaction Process

To ensure adequate compaction, you will need to install the base in lifts (layers). If you will be using a hand tamper, spread an even layer of gravel about 2" thick. If using a plate compactor, you can spread the gravel in 3" to 4" layers. If using a plate rammer or vibratory roller, you can spread and compact in 4" to 6" lifts.

Wet, but do not saturate, the base with water as you compact. When it cannot be compacted further, add the next layer of gravel and compact. **Take your time - do not rush this step.**

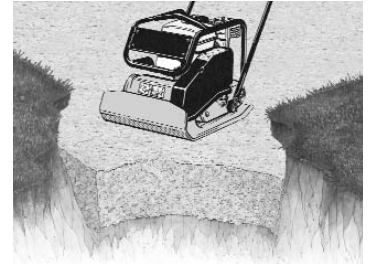

Continue to add and compact material until the top of the base is approximately 2³/₄" to 3" below the final height of the finished pavement. Verify this by setting string lines to the pavement's final elevation. The distance between the base and the final elevation should be uniform throughout. The remaining space is for the 1" sand bed and pavers after they have been compacted into place. If necessary, add or delete base material to bring it to the desired slope and grade, and compact it well.

Be sure the base slopes away from buildings, and has a pitch or crown in walks and driveways. Check depth measurements along the string lines when placing and compacting the base, and when setting and compacting the pavers.



Rule of Thumb:

When the bedding sand is 1" thick, the base should be 3" lower than the finished elevation for 6 cm pavers. The base should be 3³/₄" lower for 8 cm pavers. If you need to fill low areas after compaction, use base material to adjust the base elevation. Do not use bedding sand!

You need to pay particular attention when compacting near corners, concrete/granite curbs, walls, and utility structures. You may have to use smaller equipment or even a hand tamper. You may even wish to purchase a special tool, such as PAVETECH's Pounder®, which is designed to compact tight areas. When using a hand tamper, compact in 1" to 2" thick layers. If necessary, mix some dry cement into the soil to stabilize it prior to compaction. On larger projects, such as sidewalks with granite curbs, consider using flowable fill in these areas. Flowable fill is self-leveling and can be excavated at a later date if necessary. It is available from most ready-mix concrete suppliers.

If the surface of the base after compaction has a coarse finish that will allow bedding sand to migrate into it, spread and compact a choke course of fine material into it. Inspect



Tip: Use the threshold of a door or steps to establish the finished elevation of the pavement.

joints at curbs and around utility structures and catch basins that might cause sand loss after installation. Cover these areas with a 12" wide strip of geotextile fabric, or filter cloth, to prevent settlement due to the loss of bedding sand.



Rule of Thumb:

The compacted thickness of the base should be within -1/2" to +3/4" of the recommended thickness. The finished surface of the base shall be uniformly flat and should not deviate by more than +/- 3/8" when tested with a 10' straightedge. Pitch or crown the base no less than 1/4" per foot and not more than 1/2" per foot.

Measuring Soil Compaction

Okay, so you have completed compaction of the base. But how do you tell if it is fully compacted? If you really want to know if the base meets the minimum requirements we've spelled out, there are ways to accurately measure compaction. The sand cone test and water balloon tests are two common procedures, and as you can guess, are conducted by a testing laboratory. A technician takes a soil sample from the site and performs a test in the lab to determine its optimum density. The technician then returns to the site and tests the density of the soil, which is compared to the laboratory value. The results are expressed in Proctor density and if they are within a certain percent, it is considered passing. Another method involving a testing lab is the nuclear density test. A technician uses a nuclear instrument that emits radioactive waves to determine if the density of the soil on site meets the required density. In addition, a tool known as a Dynamic Cone Penetrometer also measures compaction density. While not as accurate as the other methods described, it pays for itself in more ways than one. Testing only two jobs through a lab will cost about the same as this tool. The most common problem we see with any type of pavement is settlement, so verifying that you have properly compacted the base is very important! Remember, when it comes to soils, whatever you do not compact...Mother Nature will!



Rule of Thumb:

If you can drive the 10" spikes for the edge restraints into the base with 2 or 3 relatively easy blows, most likely the base has not been adequately compacted!

EDGE RESTRAINTS - *Holding it together!*

Assuming you have selected to use a type of manufactured edge restraint, now is the time to place and set it. By now, you know we consider *PaveEdge*® to be among the best, but what type should you use? *PaveEdge*® RIGID is superior to all types. Its structural design can withstand nearly any type of disruptive loads, yet it is flexible enough to follow contours and can be cut to accommodate curves. *PaveEdge*® FLEX is a specialty hardscape combination edging that allows for a balance of strength, flexibility, and versatility. Unless you expect the pavement to see traffic from trucks and other heavy-duty vehicles, FLEX should do the trick for just about all residential projects.

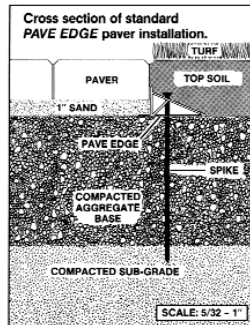

Snap a chalk line directly on the base to mark the location of where the perimeter of the pavement will be. Place a length of *PaveEdge*® along the line and secure it by driving 10" spikes into the pre-drilled holes. Be careful not to over-strike the spikes as the head is about to touch the edging! Continue until you have set the lengths along the perimeter. On narrow pavements such as walkways, the *PaveEdge*® can act as sand screed guides instead of rails by notching the ends of a 2" x 4" screed board to ride along the top of the edging.



Rule of Thumb:

Spike every 2' for patio, walks, and pool deck applications and spike every 1' for driveway and commercial projects.



Tip: If using *PaveEdge*®, set one side securely. On the opposite side, drive the spikes part way into the base. Start your installation along the side which has been fully set. If you need to adjust the pavers to accommodate the laying pattern when you reach the opposite side, simply remove the partially driven spikes and reposition the *PaveEdge*®, then set it permanently.

Some contractors prefer to install *PaveEdge*® after the pavers have been laid. Using a trowel, cut straight down the side of the pavers through the sand setting bed down to the base. Pull the sand back, using care not to scrape up base material. Next, place the *PaveEdge*® on the base and push it tight against the pavers so that the frost lip slides under the sand bed. You may have to tap it with a hammer to get it snug. To set it permanently, pound in the spikes until the head touches the edging.



Tip: Use regular steel spikes, not galvanized.

BEDDING SAND – *A resting place!*

The amount of sand you want to spread and screed depends on the size and configuration of the pavement. Place only the amount of sand that will be covered with pavers that day. If you spread more than what will be paved, it will dry out overnight - not a good scenario - or it could get soaked in a rainstorm. And in a residential area with a lot of kids...well, what could be more tempting? You don't want to have to re-do anything the next day!

If the sand is not used in one day, cover the piles with plastic or canvas. It will prevent the sand from getting too wet if it rains or too dry from hot summer breezes. Although sand should contain some moisture in order to compact well, it should not be wet.

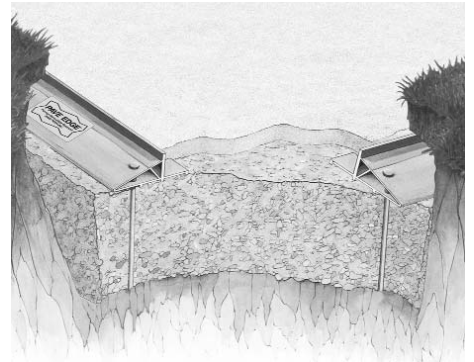

Tip: To determine how much the sand will compact, place a shovelful of sand onto the ground and spread it to the thickness you intend to screed it at. Place a paver on top and tap it down with a rubber hammer using short sharp blows. The difference in height is the compaction rate, or surcharge, of the sand.

Screeding

Screeding is the process of smoothing the bedding sand prior to placing the pavers. Start by laying two 1" or 1 1/2" diameter round pipes on the base spaced 6' - 8' apart and parallel to each other.

They are used as a height guideline, so use the same diameter pipe on the whole job. Set string lines to the desired elevations of the finished pavement and check the height of the screed bars to be sure that the screeded sand and pavers conform to finished elevations when compacted.



Tip: The top of pipes should be 2" below finished elevation for 6 cm pavers and 2 3/4" for 8 cm pavers.



Tip: Use short lengths of pipe for small or contoured areas and tight bends.

Pack a small amount of sand around the pipes to hold them in place. While it's okay to adjust the elevation slightly by adjusting the sand surrounding them, *do not use sand to correct any deficiencies in the base*. Now, cover the pipes and the area between them with sand. Next, level the sand by drawing the screed board along the top of the pipes with a backward motion. If room permits, slide the pipes backwards or move them to the adjacent area and repeat the procedure. Fill the voids they left in the setting bed with sand.



Tip: When moving the screed pipes, leave 1 in place; move the other pipe to the opposite side and set it 6'-8' away from the pipe left in place.



Rule of Thumb:
Sand should not be used to fill depressions in the base! Use base material to fill in these areas.



Rule of Thumb:
Do not walk on or compact the bedding sand prior to setting pavers.

PAVER INSTALLATION

Delivery and Handling

Pavers will be delivered and unloaded at the job site in cubes. Be sure to check the shipment when it arrives to make sure it matches your order with respect to shape, color, size, and quantity. If a problem arises, contact your supplier immediately for instructions. **If adjustments need to be made, now is the time - not after the pavers have been placed.** Every cube comes with tags that provide important information about the product. Be sure to read them. If your **Ideal Authorized Dealer** offers spyder delivery, have them place the cubes as close to the work area as possible. Instruct your crew to use caution when cutting the steel bands that hold sections of pavers!

The Layout - *It's hip to be square!*

It is important to start laying pavers at a 90° corner or along a straight edge. A wall or corner that appears perpendicular to your starting point may not be a square 90°. Here is an easy procedure to establish a 90° angle: it is known as a 3-4-5 triangle and generally requires two people.

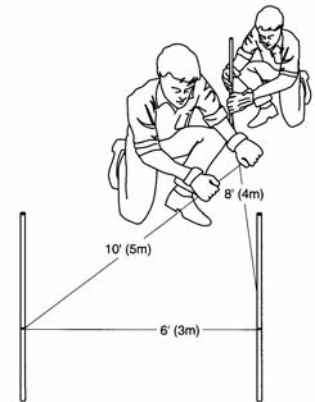

- Drive a stake at the corner you wish to use as the starting point. Measure and place a stake 6' across the base and another 8' up the side.
- Now measure a line exactly 10' long and string it along the diagonal of those two stakes. Adjust the stake on the 8' side until it meets the 10' mark precisely.
- You now have a 90° angle from which you can begin laying pavers.

Here is a quick way to establish a perpendicular line if there are no corner walls involved.

- Measure and mark the length of the edge, or line, from which paving will begin. The line can be 10-20' long. This line is where an edge restraint will be placed, or where one already exists.
- Mark the half way point exactly on the line that was just measured. In other words, divide the line in half.
- Take one tape measure and extend it from one end of the line at an angle toward the center. Be sure the tape extends past the middle of the line by a foot or two.
- Take a second tape measure and extend it from the other end of the line at an angle toward the center.
- Overlap one tape on the other and match the length of both tapes. The same marked dimensions on each tape should be touching each other.
- Snap a chalk line from the edge to the point where the two tape measures cross the center of the line. This line is now perpendicular to the line from which paving will begin.

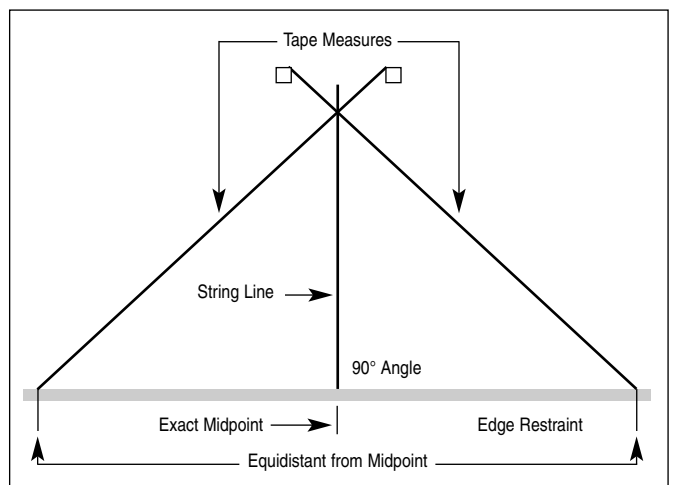

Establishing a perpendicular line

Holding Straight Lines - *How to keep from going astray!*

To help keep the pavers straight as they're placed, use string lines pulled perpendicular to the laying edge as a guide to holding the laying pattern.

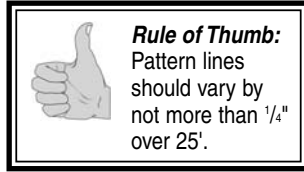

Tip: Snap parallel chalk lines spaced 6'-8' apart directly on the bedding sand down the length of the screeded sand. On narrow layouts, snap a line down the center.

Laying Patterns – *You've got choices!*

Most **ideal** pavers can be installed in a number of laying patterns. The most popular ones are 45° and 90° herringbone, running bond, and a variety of basket weave or parquet patterns. Some pavers, such as Symetry® and Anchorlock®, have shapes that lend themselves to laying patterns specific to their geometry. We've shown a few of the most popular patterns in the **Reference Section** of this guide. Additional patterns for a particular shape may be shown on their 8 1/2" x 11" product sheet, which can be found in our **Contractor Catalog**.

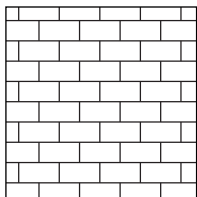

Running Bond

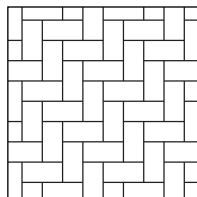

90° Herringbone

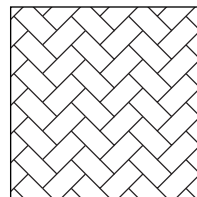

45° Herringbone

Circles and Fans

If you are laying a pattern with circles and fans, it is best to start at the center of the circle and work your way out. Refer to the charts in the **Reference Section** for the sequence in placing the shapes of the style you are using. Screed only enough sand for the setting bed that allows you to comfortably place the pavers within arm's reach. As the diameter of the circle increases, you will be able to work off it to place additional stones. Another method is to place half of the circle first, then lay the remaining half by working from the previously installed area. Fans are laid in a similar manner. With when it comes to laying fan patterns, it is important to know that the dimensions of even standard fan patterns can vary due to the size of the joints between stones as they are placed.

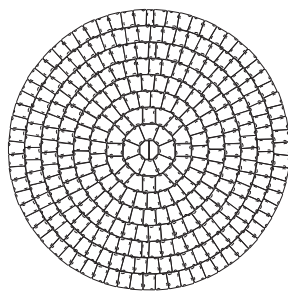

Yankee Cobble™ Circle



Tip: Lay a piece of plywood on the sand setting bed to minimize footprints, pulling it away as you expand the rows of the circle outward.

Placing fans takes some expertise and should be done by someone on your crew who has experienced doing them. Some stones in our Yankee Cobble™ and MillStone™ Circle Paks need to be cut when installing fans.

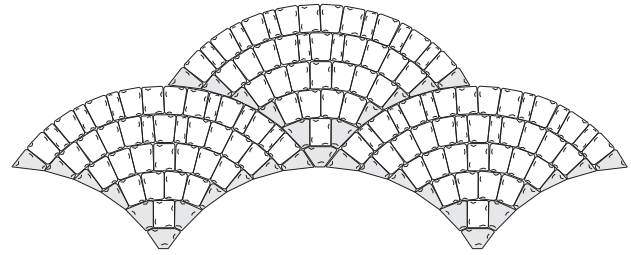

Yankee Cobble™ or MillStone™ Fans



Tip: Give your crew experience by having them practice laying patterns with various shapes. A concrete floor or on the base at the job site will do fine. Snap a centered chalk line for a guide, pick a pattern, and practice!

What to Use

In many cases, the type of laying pattern you select is a matter of preference for appearance. For most residential applications, any pattern will suffice, although we do not recommend the use of the basket weave patterns for driveways. In order of performance, herringbone patterns provide the greatest degree of interlock, followed by running bond and finally, basket weave. Stack bond should only be used with 8" x 8" and 12" x 12" Plaza Pavers™ for applications limited to pedestrian traffic.

Starting Laying Patterns

Doing patterns is like painting by numbers. For the often-used patterns, once you get started, you simply follow the common laying order. Plan to spend a little extra time when you begin laying the first few rows of pavers. The order in which you start placing the units establishes the rhythm and pattern for the remaining courses. We've shown the starting order for herringbone patterns below (see page 35 for more). Other shapes have variations in their order of placement. When laying circles with Yankee Cobble™ or MillStone™, you will need to start laying stones in the middle of the circle.

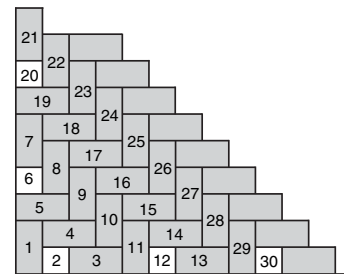

90° Herringbone Pattern

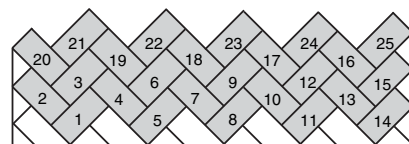

45° Herringbone Pattern

Selecting Pavers

Shade variations are inherent in the character of colored concrete products made using natural ingredients. When manufacturing our color blends, we use a process that mixes colors to produce a variegated blend that is randomly dispersed throughout the pavers. Cubes of product may contain different predominance of the color blend.

Always take pavers from several cubes simultaneously, and from multiple layers within each cube, to achieve a proper distribution.

Work diagonally through the cubes as shown in the illustration, or select pavers by working vertically down full straps, or sections. Shade variations are even more apparent in solid colors. When installing, it's important to pay particular attention to blending shades of color in order to avoid creating "color splotches" throughout the pavement.

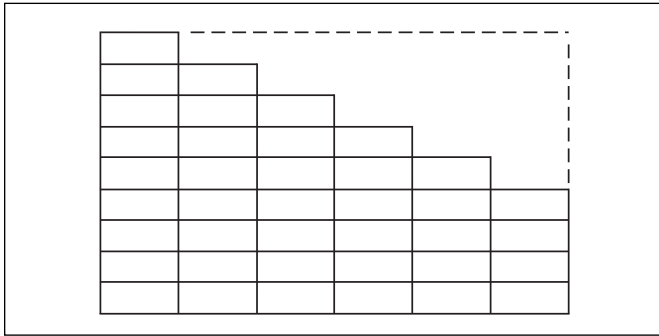
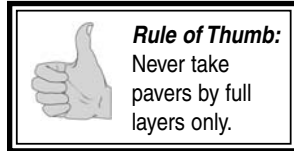

Work diagonally down through the cube to blend colors when installing

Placing the Pavers - *The wearing course!*

Placing pavers quickly and accurately with minimum effort is the key to having a productive crew. The actual placing of each paver is one of the most important tasks of the operation. While some people prefer to kneel while setting the pavers, a standing position allows turning, bending, and reaching across longer distances. Whatever position is used, you want to "feed" the installer with a constant supply of pavers placed within arm's reach. A paver cart makes moving stacks of pavers faster and easier.

Joint Size: While most styles of pavers have spacer tabs molded into their sides, the optimal size of the joints between pavers should be $\frac{1}{8}$ " to $\frac{1}{4}$ ", though with circles and fans, joint spacing may vary. Spacing too tightly can lead to chipping and difficulty in maintaining pattern lines. Pavers spaced too far apart will result in the loss of interlock between units. The easiest way to maintain consistency in the size of the joints is to use the "touch and drop" method.

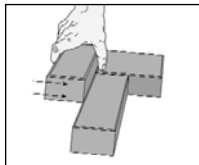

While holding a paver between your thumb and fingers, touch the bottom half against the sides of the pavers already set on the sand. (Don't click against the pavers already in place so hard that they move.) Release your grip, guiding the paver to drop directly down onto the sand.

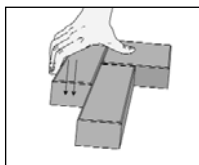

Rule of Thumb:

Do not to slide the pavers across the sand setting bed or click too hard against pavers already in place.



Tip: For larger pavers such as our Yankee Cobble™ and 8" and 12" Plaza Pavers™, try using PaveTech's® Paver 'Paw'.

Our traditional styles have chamfers along the edges of the top surface. Yankee Cobble™ should be placed with its embossed surface and pressed corners as the top face. MillStone™ can be installed either side up, as can our Georgetown Colonial® Pavers, although for a more rustic look, try laying Georgetown Colonial® Pavers with the chamfered and square edges face up in a random fashion.



Tip: When more than one person is placing pavers, rotate installers frequently to avoid having sections where pavers might be laid with different joint widths. This is especially true on projects with long laying faces.



Rule of Thumb:

When paving an incline, start at the lowest point and lay pavers uphill.



Rule of Thumb:

Typically, a man can install about 30 sf of pavers per hour.

Always work from on top of the previously paved surface as the pavers are being installed, staying a foot or so back from the edge. Do not work from the sand side. Stop about 20" short from the edge of the screeded sand to prevent it from collapsing away from the paving.

The 'Pyramid'

Here's a technique that works well for large open areas and helps keep a herringbone pattern straight. It is known as 'building a pyramid.' Snap a line on the bedding sand perpendicular to the edge from where paving begins; the perpendicular line is the center of the pyramid. Begin laying the pavers on each side of the line. As paving progresses, a pyramid shape takes place. This method features two laying faces, which allows two people to set pavers at the same time. When you begin placing the pavers, it's important to work on both sides of this centered chalk line, keeping an even mass of pavers going on each side. If you work on only one side, you'll end up with a mass that has no twin to hold it back. It will slowly creep to the other side of center, causing problems when you start laying the twin side. Work on both sides at the same time.

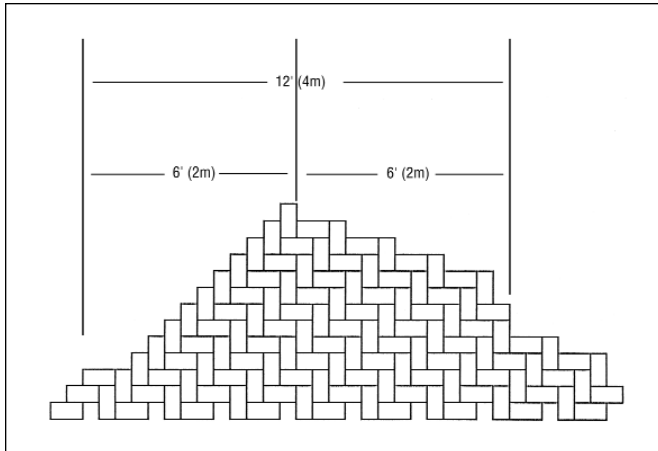

Pyramid technique for maintaining pattern lines

Openings

When laying pavers around openings, such as tree wells, man holes, and other utility structures, use string lines to maintain your laying pattern so the pavers will meet uniformly on the other side of the opening. In addition, be sure there is an adequate edge around the opening to restrain the pavers.

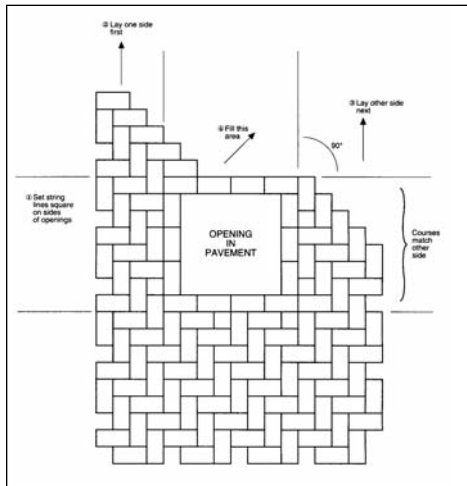

Procedure:

- Pull perpendicular string lines or snap chalk lines on all four sides of the opening.
- Lay pavers on one side, then the other.
- Count the courses needed to surround the opening on each side. They should be equal in number on both sides.
- Then fill around the remaining side of the opening.
- Cut pavers to fit against the edge restraints around the opening.



Tip: Pour a concrete collar, square or rectangular in shape, for a finished edge around utility structures and castings.



Tip: Place a border of full-sized pavers (soldier, string, or sailor course) against the edge restraint. This creates a neater appearance than placing cut pavers against the edge of the opening.

Curves and Changing Direction

When the pavement changes direction you may have several choices on how to handle the laying pattern depending on which

one you are creating. For instance, herringbones and patterns specific to a geometric shape are continued without change into the curved area, where they are cut to fit along the edges of the pavement. Running, or stretcher bond as it is sometimes called, can be handled several ways. The curved section can be changed to a herringbone pattern and then back to running bond. When a change in direction is called for at a 90° corner, make the transition along the 45° axis by laying the “ladder” to turn the pattern.

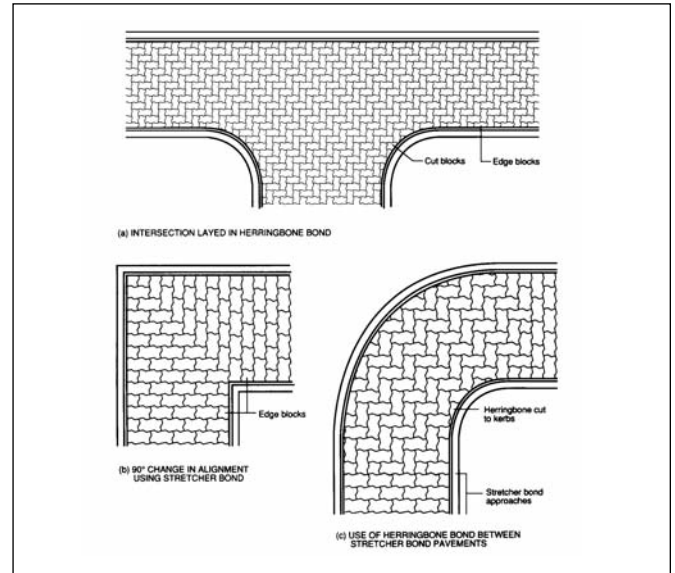

Always avoid creating construction joints caused by interrupting the pattern and never try to ‘bend’ pavers out of their pattern when laying around a curve. The exception to this is when you are using rectangular pavers in a “head-on” running bond that is being placed lengthwise, or parallel, to the direction of the pavement.

Soldiers and Sailors - Controlling the borders!

We strongly recommend the use of a border course in all pavements - both curved and straight layouts. The most popular type of coursing is a “soldier” course of Boston or Georgetown Colonial Pavers® placed perpendicular to the

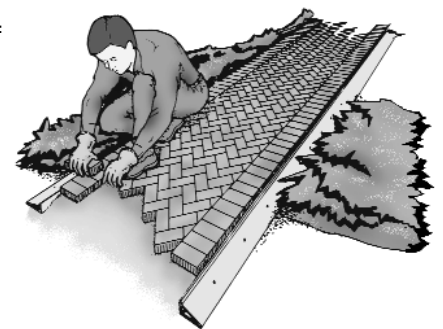

edge (3 pcs/lf), though other styles and sizes can be used. A border course not only provides a cleaner look to the pavement, but also serves as a structural component that secures small cut pieces at the edge by surrounding them with full size pavers. When Boston or Georgetown Colonial Pavers® are laid parallel to the edge they are known as a single “sailor” course. Two rows laid in this manner is known as a double “sailor” course. Both are illustrated in the **Reference Section**. Other styles and sizes may be used with our Yankee Cobble™ and MillStone™ pavers.

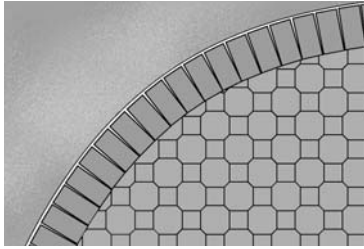

As the pavers come to a curve, place them to within 4" of the edge. If using Boston or Georgetown Colonial Pavers® as the soldier course, mark the pavers in the field 8" in from the outside edge and

cut them along the line. Clean the 8" space you've created and lay in your soldier course. If the curve is tight, cut every other paver for the soldier course length wise into wedge shape pieces to eliminate any gaps that may occur between them.



Rule of Thumb:

Gaps between pavers used in a soldier course along a radius should not be greater than 1/2" when measured at the outside edge.



Tip: Use a piece of *PaveEdge® FLEX* and a crayon or magic marker to mark out a radius on pavers. *PaveTech* makes a tool called *QuickDRAW* that is designed specifically for accurate measuring and marking.



Tip: At 90° corners, cut Boston or Georgetown Colonial Pavers® used in the border course along a diagonal for a professional finished appearance.

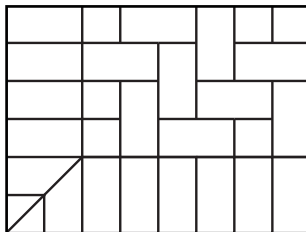

Boston or Georgetown Colonial Pavers® cut along diagonal at 90° corner

Cutting Pavers – The professional touch!

Cutting is an integral part of almost every paving job. It is one way to separate the amateurs from the pros. To do the best quality job for your customer, you must make clean and accurate cuts. In this section, we'll look at the types of tools and the methods for cutting pavers.

Paver Splitter

Splitters use a lever that acts as a guillotine to split a paver. The advantages of splitters are that they are less expensive and quieter than masonry saws.

They don't make as smooth an edge as a saw does, but they work fine for most jobs. After a short learning session, you'll find splitters relatively easy to use. Mark several pavers in different places - near an end, in the middle, and diagonally - and practice placing, clamping, and splitting the pavers. Try to hold the pavers at a slight angle to produce an undercut. Also, try cutting as close to an end as

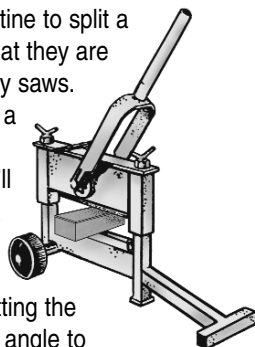

possible without making a jagged cut. Because small pieces of paver may pop from the blade, **always wear safety glasses** when using a splitter.

Saws

Saws are equipped with a diamond blade and are electric or gas-powered hand-held cut-off saws or masonry table saws. Saws make very smooth and accurate cuts. You also can cut thin pieces using a saw although, they should never be less than 3/8" because they can crack and be thrown from the saw while the paver is being cut. Hand-held cut-off saws are popular because they can cut pavers in place. Table saws require someone to remove the pavers once they are marked and carry them to and from the saw, but they do collect the cutting residue into the tub below. As with any piece of power equipment, read and follow the saw manufacturer's instructions.

The blades used with either type of saw can be "dry" or "wet" cutting types. Wet cutting reduces blade wear and overheating, but requires that the pavers be rinsed immediately and thoroughly of the wet residue. Otherwise a paste can form that can stain the paver and become very difficult to remove. Dry cutting avoids a wet paste, but also can stain the pavement if not thoroughly removed by brushing or blowing. While many contractors operate hand-held saws with a dry-cut blade, this method creates clouds of dust that can be harmful if inhaled.



Protect your crew with approved respirators, safety goggles, and ear protection. You also may want to wear coveralls to keep dust and debris off your work clothes. And don't make the mistake of using a blade designed for cutting asphalt to cut our concrete pavers. You'll burn through it in no time flat! Let the blade do the cutting. Never force the blade through the pavers!

And asking neighbors to close their windows in their house and vehicles during this part of the installation makes for good customer relations.



Rule of Thumb:

Cut pieces should not be less than 3/8" wide for pedestrian and residential applications, nor smaller than 1/3 of a full size paver for street applications.



Tip: Try *PaveTech®/Probst's® QuickSAW* attachment for hand-held gas powered saws. It makes cutting in place easy and simple.

With experience, you'll develop a steady pace for making cuts. Mark the pavers to be cut with a magic marker, soft lead pencil, or marking crayon. A quick way is to snap a chalk line or draw a line while pavers are in place on the bedding sand. You can spray the chalk line with clear acrylic to prevent the mark from being washed or blown off. The paver to be cut should be marked with an "X" on the remaining end to distinguish it from the piece to be used.

Compacting Pavers - Tamping into place!

Hold the sand! - After the pavers have been installed and the edge restraints securely set, sweep the surface clean of any debris and use a plate compactor to tamp the pavers into the bedding sand and vibrate sand up into the joints. Adjust the speed of the machine so that it runs with a high vibration, but at a low amplitude, in order to avoid a jumping motion. (This is especially important with Symetry® stones.) Start on one edge of the pavement and compact the perimeter. Compact the rest of the pavement in 4" - 6" overlapping passes (or about a half a paver width). Now compact the pavement again, but this time, in the opposite direction. All of the pavers must be tamped by at least two passes of the compactor; 8 cm thick pavers will take more time than 6 cm. **Do not rush this process!** Make two or three passes at 90° angles to each other. Inspect and replace any broken pavers.

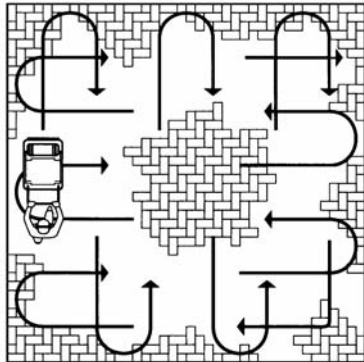

Tip: Check your distribution of color throughout the pavement before you compact.



Rule of Thumb:
Do not compact within 3' of an unrestrained edge or the pavers will creep out.

Sand Please! - Next, spread sand over the surface and sweep into the joints with a sweeping and slightly pounding motion using a stiff bristle push broom. Run the compactor over the

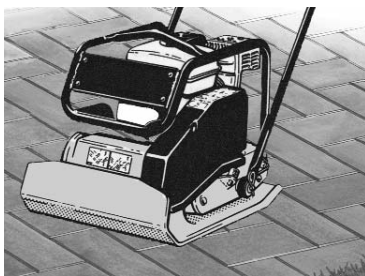

pavers from one side to the other as previously discussed. Remember that wet joint sand will not fill joints easily. If the sand is wet, spread it on the pavers, and let it dry before sweeping and vibrating it down into the joints. It is okay to leave a thin layer of sand on the surface as you vibrate. As the compactor moves over the pavement, brush more sand into the joints, sweeping aside the excess sand. Repeat this procedure until the joints are full and sand can no longer be vibrated down into the joints. Sweep and remove excess sand. Check the joints to be sure they are completely full after vibrating by inserting a putty knife into the joints. If full, the metal blade will barely move into the joint with hard pressure.



Tip: Use masonry sand (ASTM C-144) in the final sweeping step to fill the joints completely.

Oops...a broken one! If any pavers become damaged, remove them with a Paver Puller or by placing two large screwdrivers in the joints on opposite lengths of the paver and wiggle them back and forth to pry the paver straight up. Tamp the replacement pavers into place with the compactor.



Tip: If you plan to leave the job before the pavement is compacted in its entirety, protect uncompact and unrestrained edges with plastic or canvas and temporarily set PaveEdge® against unrestrained edges.



Rule of Thumb:
Never allow anyone to drive over the pavement until it has been compacted and the joints filled with sand!

SandLock™

SandLock™ joint sand binder is available "Premixed" or in "Concentrate" form. **Premix** is ready to use, while **Concentrate** is mixed at the job site with joint sand. Dump 9-11 shovelfuls of sand into a wheelbarrow, add 2 lb of Sandlock powder, and mix thoroughly. Both products are swept and compacted into the joints. As with all types of sand binders, **it must go to the full depth of the joints**, otherwise it can wash out and leave a sticky mess on the pavement surface that will be difficult to remove. Be sure to ask your **Ideal Authorized Dealer** for a free copy of the **SandLock™ CD**. It illustrates how easy **SandLock™** is to use!

Filling the Joints: Evenly spread the **SandLock™** mixture over the surface of the pavers. Using a push broom, sweep the mixture into the joints with a slight pounding motion. Once a substantial area has been swept, run the plate compactor over the pavers in overlapping passes. Sweep more **SandLock™** mixture into the joints and compact the area again. Continue this procedure until all joints are full and sand can no longer be vibrated into them.

Clean the Surface: Once you have completed the compaction process, carefully sweep the area entirely clean of the sand mixture. You may even wish to use a blower to remove all of it, but be careful not to blow the mixture out of the joints. Save any unused portion in a sealed bucket to use on another project.

Activate: Starting at the lowest elevation, spray the pavement with a fine mist of water until you see the joints start to shed water - about 1 minute. To fully activate the **SandLock™**, wet the pavement with copious amounts of water for several minutes before moving to the next section of pavement. Allow the area to dry completely, including the joints, prior to permitting traffic to use the pavement. Drying typically occurs within 24 hours, depending upon weather conditions.

Precautions: Once mixed, the material must be kept dry prior to application. Do not use **SandLock™** during rainy conditions. Do not allow **SandLock™**, or the unactivated mixture, to come in contact with asphalt.

FINISHING

To finish the job, sweep the pavers clean and hose down the surface with water. Be careful not to wash sand out of the joints when rinsing. If you have not used **SandLock™**, let your customer know that it is normal for the sand in the joints to settle somewhat. Leave a small amount of sand for them to sweep over the finished pavement to fill any joints that may settle



Boston Colonial Pavers®

during that initial period of "lock-up." If landscaping is part of your contract, complete the work by adding sod over the **PaveEdge®** and planting as needed. **And don't forget to collect the final check if you haven't already done so!**



Tip: Leave a few pavers for your customer to store away as replacement pavers should the need arise in the future.

Congratulations - A sense of accomplishment!

Pride in what we do is an important element to personal and job satisfaction. Your work is your signature and speaks volumes more about you than any words can say. In just a short period of time, you have built a beautiful pavement that you and your crew should be proud of. Take some time to review how it looks. Are the pattern lines straight? Are the cuts neat? Do they fit tight without gaps? Is the overall pavement surface uniform and free of low or high areas? We have included a list of tolerances developed by ICPI in the **Reference Section**. Refer to it to compare your work to industry guidelines. If you have met them...terrific! Otherwise, learn from it and strive to meet or exceed them on your next project. After all, pride is not a one time thing. It is an attitude that is reflected in everything we do and striving to do better each time we do something!



Pavers by Ideal® Warranty - Peace of mind!

Pavers by Ideal® provides a lifetime warranty on the structural integrity of our concrete paving stones used in residential applications. Material installed according to our guidelines that is proven to be defective will be replaced without cost. Color matching cannot be guaranteed and replacement labor is not included. Proof of purchase is required, and other exclusions may apply. Please ask for complete details. For projects requiring extended warranty coverage, please contact your **Ideal** sales

representative for information on the conditions covered by our limited warranty.

Costing - Or did you make money?

This guide has covered many aspects for achieving a quality interlocking concrete pavement. While you depend on us to make good pavers, we depend on you to install quality pavements that will provide long-term performance and satisfaction to the customers we share. We want you to be successful in your construction skills, as well as the financial aspects of your business. We hope you profit from doing paver installations because making money is, after all, the true purpose of being in business.

Knowing your costs is essential to accomplishing this. It is important to know the productivity you can expect when installing pavers and that the scope of a project, including access to the area to be paved, the amount of cutting, and the complexity of the job with respect to curves, corners, openings, and obstructions, all of which control the speed of installation. Production rates are better on larger and wider pavements than narrow areas. Crew size, their efficiency, and the degree of paver installation experience also influence job output.

The industry has developed information that puts the typical crew at three to five people, depending on the size of the job and the tasks required. The average output for a five person crew is cited as 1,200 ft² per 8-hour day. On a per man basis, this works out to about 250 ft² per day or 27-33 ft² per hour. Productivity of edge cutting is estimated to be 25 to 30 lineal feet per hour for two men, when one marks pavers and the other cuts them.



Uni-Decor®

Most successful contractors know that true costs go well beyond how many square feet of pavers a man can install in a day. Equipment costs and depreciation, office staff and space, equipment and supplies, insurance, downtime, bad debts, and other expenses are just some of the important factors that contribute to true overhead and costs that must be covered when pricing a job.

Steve Jones of **PaveTech®** has developed cost and estimating sheets that you might find quite valuable in documenting your costs and profits. **Tracking labor hours is crucial to maintaining accurate costing. While you may price jobs by the square foot, what you are really selling is labor hours!** If you would like a copy of **PaveTech's®** job costing sheets, please contact your **Ideal** sales representative.

We also would like to recommend Charles Vander Kooi's book, *The Complete Business Manual for Concrete Paver Contractors*. He has lectured to over 90,000 contractors worldwide and has authored nine books on the construction industry. You might say we have a vested interest in your success! Contact your **Ideal Authorized Dealer** to purchase a copy.

MORE INFO YOU NEED TO KNOW

Pavement Repairs - *No ugly patch!*

If it is ever necessary to gain access to underground services or utilities, you will see one of the most important advantages that concrete pavers have over other types of pavements...the paving stones can be removed, set aside, and reinstalled without leaving a patch! Here's what you do:

Scrape sand from the joints around several pavers using a putty knife or small screwdriver. Let a hose run on the pavers you need to lift until the joints are thoroughly soaked. Wiggle the pavers up by inserting two large screwdrivers into the joints or by using **PaveTech®/Probst's® Paver Puller**. As you lift, the pavers will want to wedge themselves in against other pavers, so tap the surrounding pavers down with a rubber mallet. Once you have removed a few pavers, you'll find that subsequent ones can be lifted more easily. Remove enough stones to give you access to make your underground repairs.

Once the underground work has been performed, replace the base material. Thoroughly compact it in 3" lifts, paying particular attention to the edges to avoid future settlement. For large areas, long trenches, or projects that receive heavy traffic, we recommend flowable fill in lieu of gravel. Flowable fill is a self-compacting, non-settling base material available from ready-mix concrete companies.

If the pavers and sand around the opening were disturbed during the work, remove additional pavers back to an undisturbed course. Spread sand, screed it, then restate a few of the pavers you have set aside. Check the grade and elevation to make sure they will match the existing surface after the pavers are compacted. Place the remaining pavers back in the original laying pattern and compact them into place. Sweep sand over the area until the joints are full.



Tip: To insure a tight fit as you re-lay the pavers, scrape off any sand that has stuck to the sides and bottom of them when they were removed.

Cleaning and Sealing

When people look to use concrete pavers, most tell us they prefer the appearance of them when wet. Depending on traffic and wear, cleaning and sealing can give pavers that "wet" look for as long as five years. Although it is not necessary to seal concrete pavers, sealer intensifies their color and helps prevent stains to ensure that the beauty of a newly installed paver walkway, patio, or driveway will last for years.

Cleaning and sealing also can restore the original appearance of concrete pavers that have become exposed to dirt, stains, and weather over time.



Complete information on the proper products and procedures for cleaning and sealing are available from your **Ideal** sales representative. Be sure to ask for ICPI's *Tech Spec 6*, a comprehensive guide to cleaning and sealing concrete pavements. It covers the removal of various types of stains, general cleaning, efflorescence, the types of sealers, and their applications.

If you choose to seal, it is best to wait 60-90 days after you have completed the installation. Otherwise, you may trap the free calcium hydroxide in the body of the paver that will turn to efflorescence on the surface. Our next section covers this in more detail.

In general, the steps for proper cleaning and sealing are:

- Remove stains on specific areas.
- If there are no signs of efflorescence, clean the pavement with a commercial detergent such as **Simple Green™**. If efflorescence is present, clean the pavement with an acid-based cleaner, applied and rinsed in sections, after which the entire area is flushed thoroughly with clean water. **Do not use muriatic acid!**
- Allow the pavement to dry completely for at least 24 to 48 hours, then apply 1 to 2 coats of sealer using a roller or low pressure spray.

There are a number of cleaners and sealers available. Be sure to use products specifically for concrete pavers. *These are commercial grade and contain chemicals that must be handled with caution.* Coverage rates may vary by manufacturer. For the purpose of estimating, **PaveChem's® PaverPREP™** or **SRW's** cleaner and efflorescence remover covers 200 sf/gal in the concentrated form. **PaveChem's® PaverGUARD®** acrylic sealer or **SRW's® Paver Seal** average about 100-120 sf/gal for two coats.



Tip: Never use sealer on pavers around a pool deck. The sealer acts like a magnifying glass and heats the surface to a temperature that is uncomfortable for bare feet.

A Word About...Efflorescence

Efflorescence is a white deposit that sometimes appears on concrete and clay masonry products. Although it can come from a number of sources, such as aggregate, soil, contaminated bedding sand, or from a concrete base or curbs, efflorescence often is a by-product of cement hydration. Technically known as calcium hydroxide, efflorescence is water soluble and it appears as a white deposit when carried to the surface by moisture. Efflorescence can occur on *any* concrete or masonry unit and is not indicative of defective concrete or a flawed product. Efflorescence does not adversely affect the structural integrity of concrete pavers. Efflorescence is water soluble and will lessen, or in some cases disappear, with rain and traffic over time. We recommend that efflorescence be allowed to dissipate naturally. Otherwise, the pavers may be washed with **PaveChem's® PaverPREP™** or **SRW's** efflorescence detergent. Because it is an acid-based cleaner, care must be taken to prevent etching the surface of the pavers being treated. **As is the case with all acid-based products, proper protective clothing and gear must be worn and safety practices must be employed.**



Rule of Thumb:

Never use muriatic acid to clean concrete pavers; it is too caustic and will burn and etch them!

SPECIALTY PRODUCTS

We have tried to cover the installation steps for most residential and commercial light-duty concrete paver applications. *Ideal* also manufactures other pavers for specialized uses. Because most of these projects involve professional design and engineering, we will cover them just briefly.

ECO-STONE® PERMEABLE PAVERS

As of March 10, 2003, Phase II of the EPA's **NPDES** (National Pollutant Discharge Elimination System) mandates that any development greater than 1 acre must now comply with new regulations regarding the quality and quantity of stormwater runoff. **Nonpoint source pollution** is caused by rainfall washing over impervious land surfaces and carrying with it pollutants that end up in streams, rivers and lakes. The **Clean Water Act** regulates nonpoint source pollution, which differs from point-source pollution.

In addition, states are required by the Clean Water Act to identify water bodies that are failing to meet their water quality standards and any impaired sites must be analyzed to determine the daily amount, or load, pollutants they can absorb without significantly impairing the health of the water. Once this is determined, the states use it to establish a **TMDL** (total maximum daily load), which specifies acceptable pollutant loads, outlines where pollutants are coming from, and specifies where and when reductions will be made so the loads are not exceeded. The TMDL is then submitted to the EPA for approval. Many cities and towns are implementing guidelines that restrict the amount of impervious surfaces that can cover a property lot. Impervious cover is any surface in the built environment that prohibits the infiltration of rainwater into the ground.

In addition to the EPA, there are other agencies and organizations addressing the issue of development and the impact of stormwater runoff on the environment and society.

LEED® - Leadership in Energy and Environmental Design is a national green building assessment system that was developed by the U.S. Green Building Council. An increasing number of municipalities and states are requiring that public projects meet LEED® objectives of a comprehensive approach for sustainable projects. Sustainable design aims to meet the needs of the present without compromising the needs of the future. Designers can earn certification for projects by obtaining credits for satisfying a number of criteria established under the system.



Rule of Thumb:

For every 100 sf of Eco-Stone, 1500 lb of EcoGrade Filtration Stone is required for 1" bedding layer, joints, and drainage apertures.

LID - Low Impact Development has emerged as an attractive approach to controlling stormwater runoff pollution and protecting watersheds. LID uses various land planning and design practices and technologies to conserve and protect natural resources, as well as reduce infrastructure costs. One of the primary goals of LID is to reduce runoff volume by infiltrating rainwater into the ground, thereby recharging groundwater, and finding beneficial uses for water as opposed to pouring down storm sewers.

Eco-Stone® is a new generation paver that creates a permeable pavement designed to improve groundwater recharge and reduce stormwater runoff. Unlike grid pavers and other porous pavements, Eco-Stone® is an 8000 psi segmental concrete unit paver - 4 1/2" x 9" - that offers all of the performance aspects of interlocking pavements and as such, can accommodate heavy loads and withstand severe climate conditions. Eco-Stone's® unique design creates funnel-shaped openings that permit water to drain through the surface and recharge naturally into the ground (if subgrade conditions allow for permeability). Drainage structures can often be reduced or eliminated. The patented configuration allows for rejuvenation of permeability should it be reduced over time, with periodic cleaning when necessary.



Uni Eco-Stone®

Eco-Stone's® unique design creates funnel-shaped openings that permit water to drain through the surface and recharge naturally into the ground (if subgrade conditions allow for permeability). Drainage structures can often be reduced or eliminated. The patented configuration allows for rejuvenation of permeability should it be reduced over time, with periodic cleaning when necessary.

As a permeable interlocking concrete paving system, Eco-Stone® is recognized nationally as an EPA-recommended Best Management Practice (BMP) for remediating stormwater runoff. Permeable pavements, such as Eco-Stone®, also are listed as one of the ten common LID-recommended practices. In addition, Eco-Stone® may qualify for up to 5 credits under the LEED® system.

Eco-Stone® Construction

Construction of Eco-Stone® pavements is similar to that of standard interlocking concrete pavers. The pavement consists of a base typically comprised of a well-draining granular aggregate consisting of a particle size generally ranging from 1/8" to 1". Eco-Stone® pavers serve as the wearing course and are placed in the desired pattern on a bedding layer of Eco-Grade Filtration Sand, a coarse stone sand 2-5 mm in size. This special stone also is used to fill the apertures in the Eco-Stone®. **Never, ever, ever use stone dust!**



Design Guidelines

The objective of permeable pavements is to store the runoff and drain it back into the ground or into a drainage system. The design involves the construction of a sufficient base that prevents the pavement from becoming saturated and losing its load-bearing capacity. The thickness of the base depends on the amount of storage required, the permeability and strength of the

soil subgrade, and susceptibility to frost, as well as the anticipated traffic loads. The storage capacity will be determined by the stormwater regulation and rainfall intensity for the locality. In many cases, a 2-year, 24-hour design storm is adequate.

Our experience has shown that the design for the base is site specific for every project according to the conditions and the drainage requirements. The report titled *Design Considerations for the Uni Eco-Stone® Concrete Paver*, provides useful information for any engineer familiar with soil mechanics and hydraulic design. Also available is Lockpave® Pro with PC-SWMM™ PP, a Windows®-based software program. It calculates structural and hydraulic design for Eco-Stone® pavements.

In general, permeable interlocking concrete pavements owe their ability to absorb and store runoff due to the use of open-graded aggregate bases. As previously mentioned, these are clean, crushed stone bases whose particle sizes generally range from 1/8" to 1". The water storage capacity in an open-graded base depends on the percent of its void spaces and its depth. The percentage of void space in an open-graded aggregate can be supplied by the quarry, or can be tested. For example, ASTM No. 57 aggregate (a commonly used base material) has an approximate void space of 40%. As a result, every 2.5 cubic inches of base can store 1 cubic inch of runoff.

A common misconception of permeable pavements is to equate the drainage void size or area to the amount of infiltration. For example, it is incorrect to assume that because Eco-Stone® has a 12% void area, that only 12% of the water will infiltrate and 88% will runoff. Considerable research has demonstrated that with proper design, it is reasonable to expect that Eco-Stone® will provide a permeable pavement capable of draining even a 100-year design storm with little or no runoff, or at the very least, equal to what is was before development.

Properly installed Eco-Stone® pavements can be snow plowed with the same equipment used for conventional pavements. Although the openings may freeze over during severe cold and ice storms, the thermal mass of the concrete units absorb the rays of the winter sun. As the pavement warms, the ice melts, and unlike conventional pavements, gradually infiltrates into the base course and subgrade.

Maintenance

Proper design and installation, including the use of the proper aggregates to fill the voids, and the implementation of a scheduled maintenance program can help prevent the loss of permeability over time. The amount and type of traffic the pavement is subjected to influences how often cleaning is required. The pavement should be kept clean of leaves and other organic material and excess sand. When necessary, infiltration can be easily maintained by periodic sweeping and cleaning with a device called a hydrovac. For commercial parking areas, we recommend this type of cleaning be performed once or twice a year. Street sweeping also is considered a Best Management Practice under EPA Guidelines for NPDES.

TURFSTONE™ GRID PAVERS

Turfstone™ is a grid paver often used to provide a grass surface capable of handling vehicular traffic. It is typically used for access lanes for emergency vehicles, overflow parking, and erosion control. A typical grid pavement consists of soil subgrade, base, sand setting layer and Turfstone™, which is placed with the false joints facing up. If compacted, plywood sheets should be placed over the Turfstone™ to minimize breakage. If the unit breaks, do not be alarmed, as the breakage will likely occur at the false joint, where it will be unnoticeable when finished. When used for erosion control, the sand layer may be eliminated, and the Turfstone™ set directly onto the base without the compaction step. The apertures are filled with stone or topsoil and grass. Turfstone™ features a flat surface that



TurfStone™

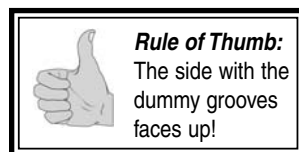

Rule of Thumb:
The side with the dummy grooves faces up!

accommodates pedestrian and vehicular traffic with relative ease. We manufacture Turfstone™ in 8 cm thickness in a size of 24" x 16".

BULLNOSE COPING

Our BullNose Coping pavers are the perfect finishing touch for pool decks, jacuzzis, or stair treads. They complement our line of *Stones and Walls with Style™* perfectly and are made in matching colors. When used as stair treads, Bullnose Coping pavers may be set with either our construction grade Paver and SRW adhesive or with mortar. As coping around pools and jacuzzis, they are set in a modified mortar bed typically comprised of:

- 1 bag of masonry cement
- 2 to 3 shovelfuls of Portland cement
- 13 to 14 shovelfuls of masonry sand (ASTM C-144)
- Acrylic bonding agent suitable for concrete in outdoor use
- Water

The installation involves the skills of a mason. The dry ingredients are mixed together first. Water and the bonding agent are added until the mix reaches a stiff consistency. Use the amount of bonding agent indicated on its manufacturer's directions. The mix is troweled on to the top of a pool or jacuzzi's concrete wall and additional material is "battered" onto the bottom side of the BullNose Coping unit. The coping units are placed in the mortar bed and are then leveled to the desired elevation. The same modified mix is used to fill the joints between the BullNose Coping and should be struck with a metal jointer at the proper time to compact the mix firmly. Unless you are skilled in working with masonry mortar, installation is tricky, so you may want to sub this out to an experienced mason contractor or tile setter.

MECHANICAL INSTALLATION

Anchorlock® is an L-shaped paver especially designed for fast mechanical installation. It is produced in a layout that permits the entire layer of stones to be lifted and installed by specialized equipment utilizing hydraulic clamps. Generally, mechanical installation is used on large projects such as streets, ports, depots, industrial yards, and airports. Experienced crews are capable of installing up to 10,000 sf of Anchorlock® pavers per day. The machines are quite expensive, so generally they are impractical for small scale jobs. The Anchorlock® shape provides the strongest structural design for industrial high-load applications and is the most cost-efficient shape for mechanical installation.



Uni-Anchorlock®

ALTERNATE SETTING METHODS

MORTAR SET

The recommended installation procedure is for the pavers to be set in 1" - 1 1/2" of concrete sand over a base of gravel, asphalt, or concrete. Although a mortar setting bed is the recommended practice for clay brick, it can be used for concrete pavers. Bear in mind that this method creates a rigid system which requires expansion and contraction joints in the pavement. Some additional thoughts are:

- Do not attempt to joint the pavers using mortar. Although the overall water absorption of concrete pavers is lower than most clay brick, their initial rate of suction is higher.
- Unless the worker is extraordinarily careful, the pavers will most likely be smeared with mortar when jointed. Rather, we recommend using **SandLock™** in the joints.
- Do not use muriatic acid to clean the pavers for any reason. The hydrochloric acid that works to remove mortar also will act on the cement used in the manufacturing of concrete pavers and etch them.

ASPHALT SET

Bituminous Setting Bed - Screed the bituminous setting bed with screed rails and screed bar to achieve a level setting bed that conforms to the required elevation and slope. If the grade must be adjusted, set wood chocks under the screed bars. While still hot, compact the setting bed with a power roller to a nominal depth of 3/4". The setting bed must be at least 1/2" and not to exceed 1 1/2" in depth. Low areas are to be re-heated and filled with fresh bituminous material. High spots in the setting bed are to be re-heated and compacted to achieve a consistent and properly sloped setting bed. Repeat process as required until entire setting bed is level and installed to the proper slope and elevation, so that when the pavers are placed, the top surface of the pavers will be at the required finished grade. Care shall be taken to fill the voids when the screed bars and wood chocks are removed. Irregularities in line and grade of the concrete slab and the corresponding bituminous setting bed may be corrected by

varying the setting bed depth only when approved by the Architect.

Mastic - After the setting bed has cooled, apply a thin coat of 2% neoprene-modified asphalt adhesive by mop, squeegee, or notched trowel over the top of the asphalt setting bed to provide a bond under the pavers. Trowels shall have serrations not to exceed 1/16" of an inch.

Concrete paver installation - If using a cold-applied adhesive, wait until the adhesive becomes tacky and just skins over before setting the pavers. Set concrete pavers in accordance with the desired pattern. Units shall be installed straight and true to the required lines. Typical joints between the pavers on average shall be between 1/8" and 1/4" (2 mm - 5 mm) wide.



MillStone™

SPECIAL CONDITIONS

Soil Cement or Rehabilitating the Base

Your customer is working on a tight budget and this time it's not just a negotiation ploy. Don't lose that job! Here's a way that might save as much as \$1.00-1.50/sf. Instead of replacing the existing soil with high-quality base material, roto-till the soil to a depth of about 6". Now take bags of Portland cement (do not use masonry cement) and place them across the area spaced apart 3' by 6'. Figure on using 1 bag per 21 sf. Open the bags and uniformly spread the cement by rake. Now work the cement thoroughly into the soil with the roto-tiller, using two passes in both directions. Spray the area with enough water that allows you to form a ball in your hand without it sticking to your fingers. Next compact the base with a roller compactor. The first pass should be done without vibration; the second pass with vibration. Dampen the base with water as needed. Allow it to harden for a day or two. Then, overlay the base with geotextile fabric, set the edging, spread your sand, and install the pavers as usual. Don't get us wrong... this method is not as good as installing the normally recommended material for the base, and it does have drawbacks. Once you add water to the soil cement mixture, you have a maximum of 3 hours to perform the compaction. In hot temperatures, this time will be reduced. It also requires that you have checked your elevations very carefully before proceeding with the work. Once it hardens, any corrections will be quite difficult to make. The base also must be considered as being impervious, so accommodations must be made to drain water from the sand layer. And as with any concrete paver installation using sand over a concrete or asphalt base, we recommend the use of a geotextile fabric to prevent sand loss should cracking in the base occur.

A CONSTRUCTION CHECKLIST

We have put together this checklist which reviews the steps that are involved in the construction of interlocking concrete pavements. You may wish to use it as a reminder to complete the tasks we have detailed in this guide.

Job Planning and Layout

- Check underground utility locations
- Estimate the amount of excavation required
- Estimate materials:
 - Base
 - Edge restraints
 - Sand
 - Pavers
 - Edge pavers, cutting

Contract

- Prepare and submit written proposal
- Finalize contract with customer

Implementing the work

- Order materials
- Plan materials delivery, flow of materials, and equipment required
- Layout job on site: Area to be paved, edges, access to site, material and equipment storage

Soil and Base

- Excavate soil and unsuitable material
- Compact subgrade and measure compaction
- Install drainage and site utilities as applicable
- Install geosynthetics (fabrics/grids) as applicable
- Place and compact base materials to required density and thickness
- Measure base elevations

Edge restraints

- Install edge restraints
- Check elevations of edge restraints

Sand

- Place and screed sand setting bed

Pavers

- Pull or snap lines
- Place pavers in desired laying pattern
- Cut and place edge units
- Compact pavers
- Remove broken units
- Sweep sand into joints, vibrate and compact
- Check joints for fullness
- Remove excess sand
- Check surface elevations

Finish

- Clean and seal pavers as required
- Clean up site

Collect final payment !!!!!



QUESTION & ANSWER SECTION

We've listed below some of the most common questions we are asked about concrete pavers.

Q: My job will require several loads of pavers overall, but I cannot accept the entire delivery at one time. Should I be concerned with the colors matching from load to load?

A: We use a precise color batching system to insure consistency in the colors from mix to mix. There are, however, other factors that affect the finished shade of any colored product made with natural ingredients. Some of these are: temperature, humidity, dye lots, and the nature of aggregate used in the mix design. If there is going to be any length of time between shipments, set aside several cubes and work them into the product sent on the next shipment.

Q: My customer plans to add on to their pavement at a much later date and has no room to store additional pavers. What shall I advise them?

A: After exposure to the elements and years of use, pavers will not match newly manufactured units. If they wish to add on to a pavement that's been in for a long time, it would be best to pull up existing pavers 5' to 10' into the pavement and blend them into the new ones. *P.S. This is why people buy all of their paint from the same dye lot!*

Q: Why are pavers sometimes stuck together in the cube?

A: This generally means that too little silica sand was spread between the layers of pavers as they were manufactured. Simply tap them apart with another paver or a hammer.

Q: I like to use stone dust because it packs so well, yet you advise against it. Why?

A: For several reasons. First, stone dust packs well because it contains a large amount of fines or dust. Quite often, the dust measures at a 200 sieve size, which is as fine as talc. When particles are this small, they actually float in the presence of water. Rutting can occur...especially with driveways. Try this easy test. Pick up a handful of wet stone dust in one hand and a handful of wet concrete sand with the other. See which one the water drains from first. As you can see, stone dust doesn't drain well. The second reason is the talc-like powder of stone dust can stain the pavers, leaving a dull film that mutes the colors, when it's swept across the surface while filling the joints. On the other hand, stone sand, which has a limited amount of #200 dust fines and meets ASTM C-33 (see page 25) is acceptable.

Q: Can pavers be used over existing asphalt driveways?

A: Yes, although you must take into consideration how the new elevation will affect existing structures, such as steps, garages, and street aprons. If overlaying, you must lay woven geotextile over the asphalt. Before laying the fabric, it also is a good idea to poke or drill, holes 2" in diameter every 4' to 6' on center through the asphalt and fill them with pea stone to facilitate drainage. Level low areas with processed gravel, set the edging, then spread the sand ($\frac{3}{4}$ " to 1" thick) and install pavers as usual.

Q: If I chose to remove the asphalt, must I also replace the base material under it?

A: Generally not. If the existing base material is the proper type and is sufficiently thick, you may only need to re-work, level, and compact it. A pretty good indication that the base needs to be replaced is if considerable heaving is noticed in the winter. If so, replace it with good quality aggregate, or fortify it using the soil cement method we've described.

Q: Can I mortar pavers in place?

A: Yes, although we do not recommend it. Unless you are **extremely** careful when jointing the pavers, the mortar will smear along the chamfered edges and top surface. As with clay brick, you would have to use muriatic acid in order to remove it, which will etch the pavers. Sweeping a dry mix of cement and sand also causes smearing.

Q: You recommend using steel spikes rather than galvanized. Aren't galvanized spikes better because they don't rust?

A: We prefer steel because it does rust! As the spikes rust, the coating that forms on the shaft helps keep it anchored more firmly in place! Besides, steel is less expensive than galvanized.

Q: Can pavers be installed in the winter?

A: Yes. If installing over a gravel base that has previously been compacted to the proper density and thickness before frost has set in and if you're willing to heat the sand to remove frost and ice, you can install in the winter.

Q: What causes a reddish-orange stain on pavers?

A: Most likely this is a rust stain caused by a high iron content in well water. You will find it more prevalent on the pavers in an area subject to overspray from the sprinkler system. It also can be caused by fertilizers with high iron content. When wet, the granules may leave a stain. Use **PaveChem's® PaverDE-STAINER®** or **SRW's® Cleaner & Degreaser** to clean the pavers.

Q: Would it be better if I lay sheets of plywood over the pavers before I run a compactor over them?

A: No. Plywood will reduce the force of the compactor, resulting in incomplete compaction. Pavers are strong enough to run a compactor directly over them. Occasionally, a few may break; simply remove and replace them prior to sweeping sand into the joints.

Q: When adding a soldier course at a 90° corner, how can I finish the pavement without having small cuts?

A: Either miter-cut the pavers or use full pavers in the corner and do your cuts on pavers 12" from the corner. Better yet, try using an 8" Plaza Paver™ as the corner piece...it looks great!

Q: Is there a way I can tell the difference between granular and clay-type soils at the site?

A: Granular soils contain gravel and sands and feel gritty when rubbed between your fingers. Clay feels smooth and greasy and is plastic and sticky when moist.

Q: How can I tell if the soil is at its optimum moisture content for compacting?

A: Besides the 'ball' test we mentioned, here's another indicator. If the soil is too dry when compacting, the compactor will generate clouds of dust. If too moist, soil will stick to the base plate of the compactor, water will rise to the surface, and eventually the compactor will bog down and not move forward. Absence of these conditions is a good indicator that the soil has the proper amount of moisture.

Q: How can I remove oil stains from my pavers?

A: There are a number of commercial grade degreasers available, though **PaveChem's® PaverDETERGENT™** and **SRW's® Cleaner & Degreaser** are among the best we've found. First, try spreading an absorbent material such as Speedy Dri™, or even cat litter to soak up as much of the oil as you can. For mild stains, follow up with a cleaner such as Simple Green. Without diluting it, pour it on the stain, allow it to sit overnight, and wash it off the following morning. If the stain remains, then use **PaveChem's® PaverDETERGENT™** or **SRW's® Cleaner & Degreaser**.

Q: Would a sheet of polyethylene or weed fabric help prevent weeds from growing in the joints?

A: No. These type of weeds are commonly found growing in all types of pavement. They germinate in joints and cracks from wind-blown seed. They pull out easily after a rainstorm, or they can be killed by treating them with a weed-growth inhibitor product such as RoundUp.® Apply **PaveChem's® EcoGUARD™** or **SRW's® Paver Seal** to prevent regrowth. Weeds are an inconvenience, so when pricing the job, sell your customer the benefits of **SandLock™** as a way of preventing them.

Q: What should I tell my customer about controlling ants?

A: Ants can sometimes find their way into the sand layer and joints. While some contractors like to use stone dust thinking that it prohibits ant infestation, we know of a number of instances to the contrary. Here again is another reason why **SandLock™** should be used during installation. Or to seal the pavement and bind the sand joints at the same time, apply **PaveChem's® EcoGUARD™** or **SRW's® Paver Seal** after installation. Both will help prevent ant infestation. Otherwise, a few granules of Diazinon dropped into the ant hill will effectively kill the ants.

Q: I'm starting to hear about impervious cover restrictions on property. Can Eco-Stone® be used to help meet this criteria?

A: Yes. Eco-Stone® is a pervious pavement that is an approved Best Management Practice (BMP) under NPDES guidelines for reducing runoff (see page 19 for more information). BMPs are either structural or non-structural. Non-structural BMPs are preventative actions that involve management and source controls. Structural BMPs include storage practices (dry and wet ponds), filtration practices (bioretention, grassed swales, wetlands), and infiltration practices (infiltration basins and trenches and porous pavements) that capture runoff and rely on infiltration through a porous medium for pollutant reduction. Eco-Stone® is a structural BMP under infiltration practices. Eco-Stone® may be able to infiltrate up to 100% of stormwater runoff. If a builder or homeowner needs to reduce impervious cover on their lot, Eco-Stone® would be a good choice for the pavement.

Q: If permeable pavements are becoming more popular, isn't gravel a better choice than Eco-Stone®?

A: While gravel driveways offer a rustic appearance, they have a number of drawbacks. For one thing, gravel is not the most comfortable surface to walk on - more than one pair of shoes has been scuffed in doing so! And over time, gravel ruts and needs to be regraded and eventually replenished. Also, gravel driveways and walkways do not lend themselves to easy snow removal - plowing, snowblowing, or shoveling. While initially permeable, the gravel densifies over time and loses its permeability, and it offers limited options for renewing the perviousness. Properly installed, Eco-Stone® can be snow-plowed and it provides an attractive, structurally strong pavement suitable for pedestrian and vehicular use. Routine maintenance is all that is needed to keep it clean, and if clogging does occur, Eco-Stone® can be restored to ensure long-term permeability.

Q: What if a commercial customer thinks Eco-Stone® pavements are too expensive?

A: While initially permeable pavements of all types are more expensive than asphalt or concrete pavements, they can save on other aspects of the project. Often, retention ponds are used to manage runoff. This takes up valuable land area that could otherwise be used for buildings, parking, or green space. Eco-Stone® provides for parking and stormwater runoff retention all in one. While initially more expensive, its cost can be more than offset by the savings it offers over traditional drainage structures and underground collection chambers that are required with conventional pavements.

Q: How does this apply to residential builders and developers? Most currently use retention ponds or detention for residential projects. Could Eco-Stone® be used instead?

A: Yes. Because the NPDES Phase II regulations now affect projects as small as 1 acre, most residential developers and builders will have to deal with stormwater runoff through the use of BMPs. Permeable Eco-Stone® offers an attractive alternative to traditional methods. Bear in mind that retention/detention ponds are not only costly to construct, but also take up valuable land area that could serve as another buildable property lot. That's a pretty nice trade-off for the developer! From the homeowner's standpoint, covenants include additional fees for the regular maintenance these ponds require. Retention ponds also present safety hazards to small children and are a breeding ground for disease-carrying mosquitoes. In many cases, Eco-Stone® can eliminate the need for retention ponds, while providing better usability of the available lot area (patios, courtyards, walkways) for the homeowner's enjoyment.

Q: Do I need an engineer for Eco-Stone® projects?

A: Our professional sales staff is ready to assist you. We have a wealth of useful information, including software that performs structural and hydraulic design. But don't get us wrong. We recommend an engineer be consulted for most Eco-Stone® projects as they can provide valuable assistance on hydrology, structural design, materials selection, and construction. However, contact us first. We'll be able to provide proper guidance in many cases.

REFERENCE SECTION

ASTM GRADATIONS FOR BEDDING AND JOINT SAND

Gradation of the sand for the bedding and joints is important. The sand must be sharp and free of clay, dirt, or foreign matter. Concrete sand is the correct material for the bedding sand because its particle sizes provide better bearing capacity and drainage characteristics than masonry sand and stone dust. Concrete sand should also be used for jointing material. The gradation for concrete sand is found in ASTM C-33.

ASTM C-33 for Bedding/Joint Sand

Sieve size	Percent passing
3/8"	100
No. 4	95 to 100
No. 8	80 to 100
No. 16	50 to 85
No. 30	25 to 60
No. 50	10 to 30
No. 100	2 to 10

Finer sand such as mason's sand can be used to complete the filling of the joints after the initial compaction and sweepings with concrete sand. The gradation for mason's sand is found in ASTM C-144.

ASTM C-144 for Joint Sand

Sieve size	Percent passing
No. 4	100
No. 8	95 to 100
No. 16	70 to 100
No. 30	40 to 75
No. 50	20 to 40
No. 100	10 to 25
No. 200	0 to 10

Coarser aggregate is used for the bedding layer and to fill the drainage apertures and joints in Eco-Stone® pavements.

Eco Grade Filtration Sand

Sieve size	Percent passing
3/8"	100
No. 4	90 to 100
No. 8	80 to 100
No. 16	50 to 80
No. 30	25 to 60
No. 50	10 to 30
No. 100	2 to 5

Gradation conforming to ASTM No. 9 also may be suitable.

ASTM GRADATIONS FOR BASE MATERIALS

The base for traditional interlocking concrete pavements is typically comprised of granular aggregate suitable for use as base material, similar to that required for conventional flexible asphalt pavements. It shall conform to the requirements of ASTM D-2940 Graded Aggregate for Bases or Subbases, or equal. We recommend 1 1/2" processed gravel or 3/4" crusher run. The base also may be asphalt, concrete, or flowable fill.

ASTM D-2940 for Dense-Graded Base

Sieve size	Percent passing
2"	100
1 1/2"	95 to 100
3/4"	70 to 92
3/8"	50 to 70
No. 4	35 to 55
No. 30	12 to 25
No. 200	0 to 8

For permeable Eco-Stone® pavements, an open-graded base material gradation such as ASTM No. 57 or No. 467 crushed stone aggregate is recommended. It should be kept free from sediment throughout the entire project.

ASTM No. 57 for Open-Graded Base

Sieve size	Percent passing
1 1/2"	100
1"	95 to 100
1/2"	25 to 60
No. 4	0 to 10
No. 8	0 to 5

ASTM No. 467 (1 1/2" stone) for Open-Graded Base

Sieve size	Percent passing
2"	100
1 1/2"	95 to 100
1"	35 to 70
3/4"	0 to 25

If the open-graded base material creates an uneven surface when compacted, a 2" layer of ASTM No. 8 crushed aggregate may be "choked" into the top of the base material for stabilization.

ASTM No. 8 Gradation Requirements

Sieve size	Percent passing
1/2"	100
3/8"	85 to 100
No. 4	10 to 30
No. 8	0 to 10
No. 16	0 to 5

ICPI - INTERLOCKING CONCRETE PAVEMENT TOLERANCES

Subbase

- Slope: Minimum 1" drop for every 5' ($1/4"$ per 15") or about 1 $1/2\%$
- Compacted density: 95% Standard Proctor

Base

- Minimum extension of 6" beyond edge not restrained by curb or building
- Compacted thickness: $-1/2"$ to $+3/4"$ to within the recommended thickness
- Compacted density:
 - Pedestrian & Driveway: 98% Standard Proctor
 - Streets & Industrial Pavements: 98% Modified Proctor
- Elevations:
 - 6 cm pavers: 3" lower than the finished elevation
 - 8 cm pavers: 3 $3/4"$ lower than the finished elevation
- Finished surface: $\pm 3/8"$ when tested with a 10' straightedge
- Pitch or crown: No less than $1/4"$ per foot and not more than $1/2"$ per foot

Bedding Sand

- Uniform thickness no less than $3/4"$ and not greater than $1 1/2"$ thick

Pavers

- Physical properties to meet or exceed ASTM C-936
 - Length or width shall not differ by more than $\pm 1/16"$
 - Height shall not differ by more than $\pm 1/8"$
 - Compressive strength shall be 8000 psi minimum
 - Absorption shall be 5% maximum

Edge/Cut Pavers

- Gaps between pavers in soldier course along radius: not be greater than $1/2"$ when measured at the outside edge
- Pedestrian & Driveway Applications: Saw cut no unit less than $3/8"$ against a border course
- Street Applications: Saw cut no less than one third of the paver unless placed against a border course
- Difference in the dimensions of top surface to the bottom shall not be greater than $1/4"$ when "undercut"

Joint Widths

- Paver field: Minimum 2 mm and maximum 5 mm
- Paver edge: Maximum $1/2"$ at outside radius

Joint Sand Depth

- Not more than $1/4"$ below chamfer

Paver Pattern Lines

- Maximum $1/4"$ variation from a 25' long string line

Pavement Surface - Completed & Ready for Traffic

- Deformation: Maximum $1/4"$ over a 10' straightedge
- Slope: Minimum $1/4"$ per foot
- Cross slope: 1 $1/2$ - 3%

TOOLS AND EQUIPMENT

The right tools and equipment reduce costs by improving productivity. Here is a list of tools we've put together that we think might be useful to you.

Rulers or Tape Measure - Used in laying out the job, checking dimensions and setting a right angle using a 3-4-5 triangle.

Chalk Line - Used for maintaining straight joint lines in the pavement and for snapping a straight line on pavers in-place that are to be removed for cutting.

Marking Crayons - Used to mark pavers for cutting.

Paver Square - Used to establish a 90° corner when laying out a job. A time-saving tool. ⌚

Stakes - Large steel pins. String is wound tightly around the stakes to mark outside lines, a change in pattern, or to maintain straight joint lines in the pavement. Grade stakes are placed with marks on them to show the elevation of the pavement surface or base.

Mason's Line - Used as string line for measuring elevations.

Tape - Gray duct tape or white medical tape worn by some installers who wrap it around their fingers to protect their skin.

Knee Pads

Line Level - Hung on a mason's line for adjusting the line so that it is level. Stakes or strings can be adjusted up or down until a level line is maintained.

Mason's Hammer - Used to under-cut pavers.

3 lb Hammer - Used with mason's chisel.

Mason's Chisel - Used to split pavers or make irregular cuts. Safety goggles should always be worn when using any hammer and chisel on pavers.

Square Trowel - Used to fill and smooth the voids left by screed rails after they are removed.

Large Screwdrivers - Useful for removing pavers or adjusting pattern lines prior to compaction.

Small Knife Trowel - Used to smooth the sand in an opening where one or two pavers have been removed.

Utility Knife - All-purpose knife for cutting string, removing plastic wrap from cubes of pavers and cutting geotextile.

Rubber Mallets - Used for aligning or seating small areas of pavers.

Metal Snips - For cutting the steel bands around paver cubes.

Level - For checking straightness and grade; usually 4-6 ft long.

Flat and Pointed Shovels, Wheel barrow, and Push broom

Vibratory Compactor - Also called a plate tamper, plate vibrator, or vibrator. Used to compact pavers into the bedding sand. Also used to vibrate sand into the joints. Sometimes used to compact base. Vibrators have a compaction force of 3000-5000 lb and vibrate 60-80 times per second.

Paver/Guillotine Splitter - Uses a lever attached to steel blades to cut pavers. The blades are made of hardened steel.

Masonry Saw - Hand held or mounted on a table. Uses a diamond blade. Hand held, either circular or cut-off, allows you to cut pavers in place on the bedding sand. When using a table-mounted saw, the marked pavers are brought to the saw for cutting. Can be wet or dry saws. Wet saw requires water from a hose to cool and lubricate the blade. Dry saw does not require water, but creates far more dust. All operators should wear goggles, a respiratory mask, and ear protection.

Screed Rails - Aluminum, steel, or plastic pipe usually 1" - 1 1/2" in diameter. The rails are placed on the finished base before spreading the bedding sand. Damaged rails should not be used.

Screed Board - A flat, straight piece of wood or aluminum. It is pulled along the top of the screed rails to level the sand. Sometimes notched on each end to rest on edge restraints.

Transit Level - A device used with a transit rod to accurately establish or check elevations of the soil subgrade, compacted base materials, pavers, and edge restraints.

Pry Bar - Used to straighten paver joint lines or move a section of pavers. This is done before the pavers are compacted.

Paver Cart - Moves a whole vertical section of banded pavers at one time. Fast and easy way to manually move stacks of pavers to the laying face. A time-saving tool. ⌚

Paver Extractor - Tool to remove installed pavers with minimal effort and no breakage. A time-saving tool. ⌚

Sand Rake - For smoothing screeded sand after screed rails are removed, leaving recessed lines to be filled.

The Pounder - A versatile tool - that can break concrete, split block, and compact tight areas. Applies up to a 5000 lb force in a concentrated area. A time-saving tool. ⌚

Dynamic Cone Penetrometer - An easy to use tool that effectively measures base and subgrade compaction.

4 x 45° Marker™ - Slotted template for marking 4 x 8 pavers for 45° and 90° cuts. A time-saving tool. ⌚

FORMULAS, WEIGHTS AND MEASURES

Formulas

Area of a **square** or **rectangle** = the length x the width

Area of a **triangle** = 1/2 the base length x the height

Area of a **parallelogram** = the length of the base x the height

Area of a **trapezoid** = 1/2 the sum of the length of the parallel sides x height

Area of an **ellipse** = long diameter x the short diameter x .7854

Area of a **circle** = square of the diameter x .7854

Area of a **circle** = square of the circumference x .07958

Area of a **circle** = 1/2 the diameter x 1/2 the circumference

Diameter of a **circle** = circumference x .3183

Circumference of a **circle** = diameter x 3.1416

Circumference of a **circle** = radius x 6.283185

Weights and Measures

Sand: 100 lb/cu ft dry/125 lb wet

3/4" Crushed Stone: 100 lb/cu ft

ASTM #57 Stone: 105 lb/cu ft

3/4" Crusher Run/Dense Graded: 115 lb/cu ft

1 1/2" Processed Gravel: 115 lb/cu ft

Decimal Equivalents of Fractions

INCHES	MILLIMETERS	DECIMAL
1/16"	1.5875	.0625
1/8"	3.175	.125
1/4"	6.35	.25
3/8"	9.525	.375
1/2"	12.70	.50
5/8"	15.875	.625
1"	25.4	1.0

GLOSSARY OF TERMS

ASTM C-936: *American Society for Testing and Materials, Standard Specification for Solid Interlocking Concrete Pavers.* The product standard for interlocking concrete pavers that defines dimensions, dimensional tolerances, maximum absorption, minimum compressive strength, maximum abrasion, and freeze-thaw durability performance through various test methods.

ASTM C-1319: *American Society for Testing and Materials, Standard Specification for Solid Concrete Grid Paving Units.* The product standard for concrete grid/turf pavers with open cells and defines dimensions, dimensional tolerances, maximum absorption, minimum compressive strength, and durability performance through various test methods.

CSI Format: The division of various construction operations, materials, and services arranged into a numerical system. It was developed by the Construction Specification Institute to assist architects in developing project specifications into a uniform format.

Chamfer: A 45° beveled edge around the top of a paver unit usually 1/16" to 1/8" wide. It allows water to drain from the surface, facilitates snow removal, helps prevent edge chipping, and delineates the paving individual units.

Concrete Grid Pavers: Concrete units that have up to 50% open area. The units are generally no larger than 16" by 24". Aggregate or grass can be placed in the openings to promote infiltration of storm water. Generally used for intermittent parking, access lanes, abating runoff, and/or controlling erosion.

Cube(s): Factory stacked pavers, strapped or wrapped, with or without a wooden pallet, for shipping and for transfer around the job site. The number of pavers on a cube varies with their thickness and shape.

Dentated Paver: A unit that is not rectangular or square in shape.

Dummy Grooves: False joints in concrete pavers that contribute to the installed pattern. Dummy grooves can enhance the appearance of the pattern and speed installation when compared to placing separate (sub) units.

Efflorescence: A white deposit of calcium carbonate on concrete surfaces. It results from the reaction of calcium hydroxide with carbon dioxide from the air. The calcium hydroxide is a by-product of cement hydration. It is slightly soluble in water and migrates to the surface through capillary action. The calcium hydroxide remains on the surface, reacts with carbon dioxide and forms calcium carbonate and water. This conversion, depending on weather conditions, will dissipate naturally over time.

ICPI: *Interlocking Concrete Pavement Institute.* An industry association that represents the interests of manufacturers, suppliers, contractors, and design professionals involved in interlocking concrete pavers throughout North America.

Color Blend: A paver with two or more colors created by blending pigments during the manufacturing process to produce a variegated appearance.

Paving Slab (or Flag): A paving unit larger than an interlocking concrete paver and with a maximum length and width dimensions of 36" by 36". Paving slabs do not rely on interlock as the principal means of load distribution.

Solid Color Paver (Monochromatic): A paver with one color.

Spacers, Tabs, or Nibs: Small protrusions molded into the sides of pavers to keep them uniformly spaced so that sand can fill into the joints. Spacer bars help prevent edge chipping and spalling. When the spacers stop below the top surface, they are known as "blind spacers" and cannot be seen once the pavers have been installed.

Engineering Terms Used in Design of Interlocking Concrete Pavement

AASHTO: The American Association of State Highway Transportation Officials, it is the governing body for roadway construction standards.

Adhesion: A property of soil which causes the particles to stick together.

CBR: California Bearing Ratio provides an index of strength for the subgrade soil which has been measured for its ability to take loads under a pavement structure. It is expressed as a percentage of the load required to penetrate crushed aggregate road base material.

Cohesion: The degree to which particles stick to one another. The ability of soil to resist shear is determined by its degree of cohesiveness.

Creep: Slow lateral movement of pavers from horizontal forces such as braking tires.

Crown: The slightly convex shape of a road cross section. It is beneficial to surface drainage and interlock.

Deflection: The temporary movement of a pavement structure due to traffic loads.

Deformation: A change in the shape of the pavement.

Density: Usually expressed in pounds per cubic foot, density describes how closely the particles of soil are compacted.

Elasticity: A soil's ability to return to its original form after a load is removed.

Equivalent Single Axle Loads (ESALs): Summation of equivalent 18,000 lb force single axle loads used to combine mixed traffic to design traffic for the design period.

Equivalent Thickness: A comparison of the concrete paver and sand layer to the required thickness of asphalt to achieve an equivalent strength. A conservative design assumes this to be 6.5".

Failure: The point at which a pavement does not adequately service its intended use.

Flexible Pavement: A pavement structure which maintains intimate contact with and distributes loads to the subgrade. The base course materials rely on aggregate interlock, particle friction, and cohesion for stability.

Frost Heave: The raising of a pavement surface due to water infiltration, which when allowed to accumulate, forms into ice in freezing climates.

Gradation: Soil or aggregate distributed by mass in specified particle-size ranges. Gradation is typically expressed in percent of mass of sample passing a range of sieve sizes.

Interlock: The three kinds of transfer of loads in a segmental pavement. They include vertical interlock, horizontal interlock, and rotational interlock. Vertical interlock is achieved by shear transfer of loads to surrounding units through sand in the joints. Horizontal interlock is primarily achieved through the use of laying patterns that disperse forces from braking and accelera-

ting vehicles. The most effective laying patterns for maintaining horizontal interlock are herringbone patterns. Rotational interlock is maintained by the pavers being of sufficient thickness, placed closely together, and being restrained by a stationary edge such as a curb.

Life-cycle Cost: An analysis tool to calculate all costs anticipated over the life of the pavement. Factors that influence the results include the initial costs, assumptions about maintenance and periodic rehabilitation, pavement user and delay costs, salvage value, inflation, discount rate, and the analysis period.

Lock Up: The initial settling phase of concrete pavers, which progressively stiffen under traffic to a point that no further settling will occur unless failure develops in the base or subgrade.

Nuclear Density Testing: A method to accurately test soil density or moisture with a device that uses a probe inserted into the soil that emits radioactive rays which are measured by a Geiger counter.

Pavement Structure: A combination of subbase, base course, and wearing surface placed on a subgrade to support the traffic load and distribute it to the road bed.

Performance Period: The period of time that an initially constructed or rehabilitated pavement structure will last (perform) before reaching its terminal serviceability. This also is referred to as the design period, expressed in years. 20 years is normally used in North America.

Proctor Density: Either the Standard or Modified method, this is a laboratory test used to determine the "ultimate" dry density and "optimum" moisture content for a soil sample. The results are compared to the actual density achieved in the field for the soil and are expressed as a percent to the laboratory sample.

Rutting: Permanent deformation from repetitive traffic loading that exceeds the ability of the pavement structure to maintain its original profile.

Segmental Paving: Pavement constructed of interlocking concrete pavers.

Skid Resistance: A measure of the frictional characteristics of a surface with respect to tires.

Subbase: The layer or layers of specified or selected material of designed thickness placed on a subgrade to support a base course.

Subgrade: The soil upon which the pavement structure and shoulders are constructed.

USCS: United Soils Classification Systems, which is used to identify the characteristics and physical properties of the various types of soils.

Terms Used in Architectural Design and Detailing of Interlocking Concrete Pavement

Nominal Size: The actual dimensions, within the allowable tolerances, of a unit.

Modular Size: The size of a unit including the typical joint space.

Engraved Pavers: Pavers that have been engraved with letters or images by molding during manufacture, shot blasting, or having a cast metal plate inset in the surface.

Herringbone Pattern: A pattern whose joints are no longer than the length of 1 1/2 paver. Herringbone patterns can be 45° or 90° depending on the orientation of the joints with respect to the direction of the traffic.

Running or Stretcher Bond: A laying pattern with continuous joint lines in one direction.

Stack Bond: A laying pattern in which the joints in both directions are continuous.

Sailor (String) Course: A single or double course of rectangular pavers laid lengthwise against (or parallel to) the edge restraint.

Soldier Course: A paver course where widths abut against (or are perpendicular to) the edge restraint.

Zoning: Using different paver colors, textures, shapes, laying patterns, and surface elevations to delineate pedestrian and vehicular areas or districts.

Terms Used in Interlocking Concrete Pavement Construction

Aggregate: Sand, gravel, shell, slag, or crushed stone, used in base materials or mixed with a cement to make concrete.

Base Course: A material of a designed thickness placed on a subbase or a subgrade to support a surface course. A base course can be compacted aggregate, cement or asphalt stabilized aggregate, asphalt, concrete, or flowable fill.

Bedding Sand: A layer of coarse, clean, sharp sand that is screeded smooth for bedding the pavers. The sand can be natural or manufactured (i.e. crushed from larger rocks) and should conform to the grading requirements of ASTM C-33. This layer is 1" to 1 1/2" thick.

Bitumen: A class of asphalt that is combined with neoprene and used as an adhesive under unit paving.

Blending Pavers: Mixing of colored concrete pavers from three or four cubes to insure even color distribution.

Clay: A cohesive soil made up of decomposed rock and microscopic fines. Clay has putty-like properties and is plastic or sticky to the touch when wet.

Coarse Aggregate: Aggregate predominantly retained on the US Standard No. 4 sieve; or that portion of an aggregate retained on the No. 4 sieve.

Concrete Sand: A coarse, washed sand conforming to size range of ASTM C-33.

Crushed Stone: A product made from mechanical crushing of rocks, boulders, or large cobblestones at a quarry. All faces of the aggregate have well-defined edges resulting from the crushing operation.

Crusher-Run: The total unscreened product of a stone crusher.

Dense-Graded Aggregate: An aggregate that has a particle size distribution that, when compacted, yields very small voids between them.

Edge Paver: A paving unit that is made with a straight, flush side, or cut straight for placement against an edge restraint.

Edge Restraint: A curb, edging, building or other stationary object that contains the sand and pavers so they do not spread and lose interlock. They can be exposed or hidden from view.

Flexible Base: See **Granular Base**.

Flowable Fill: A self leveling, low density cementitious backfill material that attains 100% compaction without tamping or vibrating. It replaces compacted soil or conventional backfill as a structural fill that drains and is no stronger than the surrounding soil after it has obtained its ultimate strength.

Geogrids: Geogrids are two dimensional or three dimensional. The two-dimensional type are flat and have small, "TV screen"

shaped openings. The material is generally placed between the soil and the base to reduce rutting. Three-dimensional geogrids are 4-8" high and provide stability under loads for cohesionless soils.

Granular Base: Crushed or quarried stone material that generally ranges in size from $\frac{3}{4}$ " maximum for crushed stone and $1\frac{1}{2}$ " maximum for quarried stone down to very small sand size particles. The sizes must be uniformly graded in various proportions that create a dense material when compacted.

Gravel: Rounded or semi-rounded particles of rock that will pass a 3" and be retained on a No. 4 US standard sieve. Gravel is one kind of aggregate.

Joint Sand: Sand swept into the openings between the pavers.

Joint Spacing: The distance between pavers subsequently filled with joint sand.

Laying Face: The exposed, vertical face of a row of pavers on bedding sand.

Laying pattern: The repetitive geometry created by the installed units. Laying patterns may be selected for their visual or structural benefits.

Lean Concrete: Concrete of low cement content used as a base material or as flowable fill around underground pipes.

Limestone Screenings: A residual product not suitable for bedding sand. It is a by-product from the crushing of rock and contains particles small enough to pass a No. 200 sieve.

Lift: A layer of newly deposited material to be compacted.

Mason Sand: A fine washed sand conforming to size range of ASTM C-144.

Mechanical Installation: The use of machines to lift and place layers of pavers onto screeded bedding sand in the final laying pattern. It is used to increase the rate of paving on larger scale projects.

Mortar: Cement and lime, or masonry cement, mixed with fine sand.

Neo-Asphalt: A rubberized neoprene asphalt adhesive for unit pavers which is cold applied with a notched trowel.

Open-Graded Aggregate: An aggregate containing relatively few fines to leave relatively large spaces between particles when compacted. Can be used as a drainage course in base design.

Paver Extractor: A tool used to grab a paver and remove it from the laying pattern.

Paver Splitter (Guillotine Splitter): A hand-operated machine for cutting concrete pavers.

Plate Compactor: Also known as a plate vibrator, which is used to compact pavers into bedding sand in order to promote interlock among the individual units.

Pumping: The ejection of bedding and joint sand, either wet or dry, through joints or cracks, or along edges of pavers when a load is applied.

Rigid Base: Reinforced or non-reinforced, concrete slab on grade.

Screed Board or Strike Board: A rigid, straight piece of wood or metal used to level bedding sand to proper grade by pulling across guides or rails set on the base course or edge restraints.

Screed Guides: Grade strips such as pipe that will guide the screed in producing the desired elevation of the bedding sand.

Sealer: A material usually applied as liquid that is used to waterproof, enhance color, or stabilize joint sand in interlocking concrete pavements.

Semi-Rigid Base: Asphaltic concrete commonly referred to as asphalt.

Silt: Material passing the No. 200 US standard sieve.

Soil Separation Fabric: A layer of fabric typically placed between the subgrade and the base to reduce rutting, also called a geotextile.

Soil Stabilization: Chemical or mechanical treatment designed to increase or maintain the stability of a mass of soil or otherwise to improve its engineering properties. Lime, fly ash, or cement are typical chemical stabilization materials. Geotextiles and geogrids are typical mechanical materials for soil stabilization.

Stabilized Base: An aggregate base where either cement, asphalt or other material is added to increase its structural capacity. The soil subgrade can be stabilized with cement, lime, fly ash, or other materials.

Stone Dust: The small residual particles left from the crushing process of large quarried stone. The gradation can range from $\frac{1}{8}$ " to as small as dust size passing No. 200 sieve.

Stone Sand: A by-product from the crushing of rock, it is a granular aggregate which has been washed to remove the dust size particles. It is generally graded $\frac{3}{16}$ " to small granules.

Topsoil: Surface soil, usually containing organic matter.

Terms Used in Concrete Paver Testing

Absorption: Weight of water incorporated by a concrete paver unit during immersion under prescribed conditions, expressed as a percentage in relation to the dry weight of the unit.

Aspect Ratio: Overall length of a paver divided by its thickness. A ratio of 3:1 is the maximum recommended for street and parking lot applications.

Compressive Strength: The measured maximum resistance of a concrete paver to loading; expressed as force per unit cross-sectional area.

Density: The mass per unit volume.

Terms Used in Permeable Concrete Pavements

BMP: Best Management Practices - Structural and non-structural practices recommended by the EPA to control and manage stormwater runoff.

Impervious Cover: Any surface in the built environment that prohibits the infiltration of rainwater into the ground.

LEED: Leadership in Energy and Environmental Design - a national green building assessment system that was developed by the U.S. Green Building Council.

LID: Low Impact Development - an approach to land development that uses various land planning and design practices for conserving and protecting natural resources as well as reducing infrastructure costs.

Nonpoint Source Pollution: Water pollution caused by rainfall washing over impervious surfaces and carrying with it pollutants that end up in streams, rivers, and lakes.

NPDES: National Pollutant Discharge Elimination System

Sustainable Design: Meeting the needs of the present without compromising the needs of the future.

TMDL: Total Maximum Daily Loads - Establishment of state guidelines for maximum pollutant loads a body of water can sustain before impairing it.

PATTERNS WITH STYLE™

Pavers by Ideal features a wide array of attractive pavers with shapes that can create engaging patterns and designs that no other paving material can match! The color, pattern, shape, and visual texture of our concrete pavers are all important elements in the design of picturesque pavements that add charm, vitality, and ambiance to any landscape setting.

Most shapes can be installed in a number of patterns. Choose from classic 45° or 90° herringbone, elegant basket weaves, traditional running bonds, dramatic circles, fans, or sweeping curves. Some pavers, such as Symetry®, have shapes that lend themselves to patterns specific to their geometry. Other styles can be installed in virtually unlimited patterns and combinations.

Any of the patterns are suitable for walkways, patios, and pool decks. While running bonds and basket weaves may be used for residential driveways, herringbone patterns provide the greatest degree of interlock. Stack bond patterns and large size pavers such as our 12" x 12" Plaza Pavers™ should be utilized only for pedestrian traffic.

And remember to check with your **Ideal Authorized Dealer** and **Ideal's Color, Product and Packaging List** for product and color availability before final selections are made!

BORDER COURSES

Although Boston and Georgetown Colonial Pavers® are the most popular choice for border courses, other paver shapes also may be used.

- 4" x 8" Soldier Course** 3 pieces per lineal foot
- 4" x 8" Sailor Course** 1 ½ pieces per lineal foot
- 8" x 8" Soldier Course** 1 ½ pieces per lineal foot

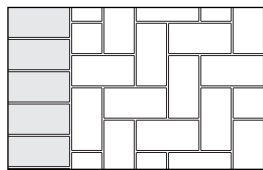

4" x 8" Soldier Course
w/ 90° Herringbone Pattern

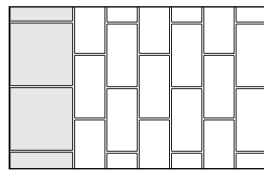

8" x 8" Soldier Course
w/ Running Bond Pattern

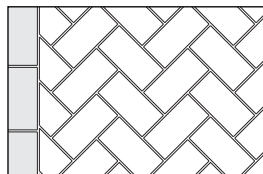

4" x 8" Sailor Course
w/ 45° Herringbone Pattern

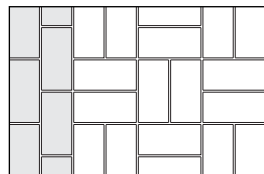

4" x 8" Double Sailor
Course
w/ Basket Weave Pattern

BOSTON COLONIAL PAVERS® GEORGETOWN COLONIAL PAVERS™

Nominal Size:
4" x 8" • 4.5 pcs/sf
6 cm or 8 cm thickness
6 cm - 108 sf/cube
8 cm - 84 sf/cube - *Made to order*



Boston Colonial Pavers



Georgetown Colonial Pavers

Boston Colonial and Georgetown Colonial Pavers may be installed in a wide variety of pattern designs including herringbones, running bonds, and basket weaves.

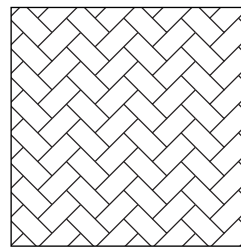

45° Herringbone

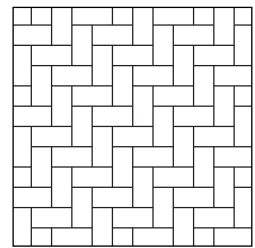

90° Herringbone

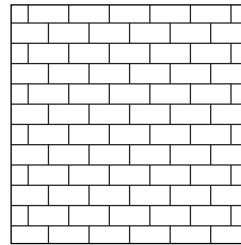

Running Bond

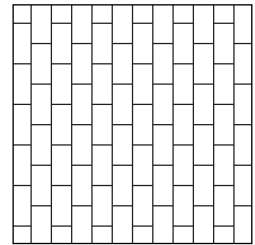

Running Bond
Head-on

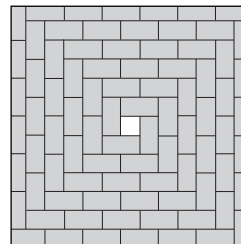

Whorling Square
with cut 4x4

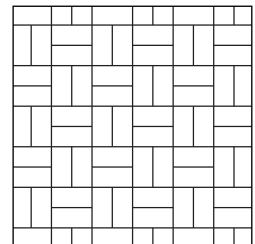

Basket Weave
Traditional #1

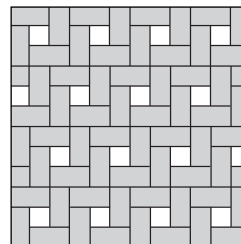

Basket Weave
Offset with cut 4x4

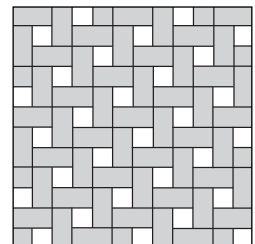

Herringbone
Variation with cut 4x4

*For patterns that require a 4" x 4" paver (shown as white units above), a 4" x 8" Double Set Plaza Paver may be cut in half to make two 4" squares with chamfers on all four sides.

UNI-DECOR®

Uni-Decor®

5 1/2" x 9" • 3.5 pcs/sf
 6 cm or 8 cm thickness
 6 cm - 103 sf/cube
 8 cm - 80 sf/cube - *Made to order*



Uni-Decor® Edges

4 1/2" x 9"
 Available in 6 cm thickness
 1.33 pcs/lf • 100 sf/cube

When installed, Uni-Decor's appearance remains the same regardless of pattern selected, however, different colors can be used to highlight pattern designs.

SYMETRY®

Symetry®

4 3/8" x 10 3/4"
 6 cm thickness
 3 pcs/sf • 84 sf/cube



Symetry® Squares

6 5/16" x 6 5/16"
 6 cm thickness
 3.62 pcs/sf • 104 sf/cube

Symetry can be installed in single stone patterns or in striking combinations with Symetry Squares.

White area shows a single Symetry paver within the patterns.

Coverage based on 100 square feet of pavement.

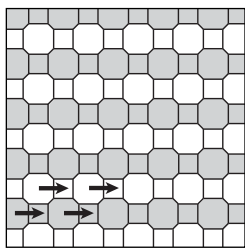

Running Bond

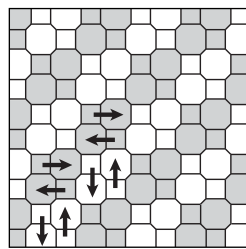

Parquet/Basket Weave

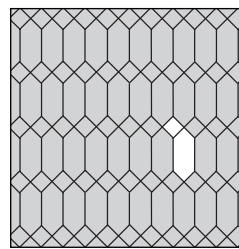

Diamond Runner
 100 sf Symetry

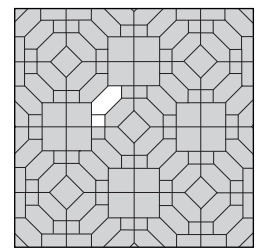

Grand Parquet
 66.2 sf Symetry • 33.8 sf Squares

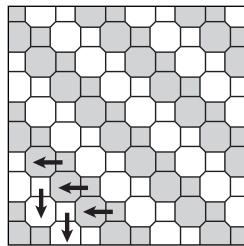

90° Herringbone

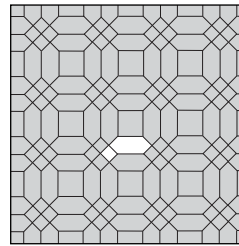

Venetian Parquet
 83 sf Symetry • 17 sf Squares

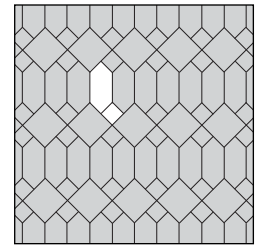

Embassy Row
 71 sf Symetry • 29 sf Squares

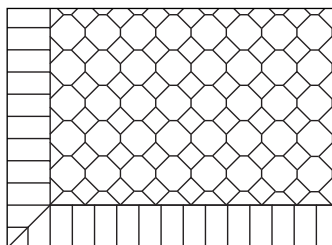

45° Herringbone

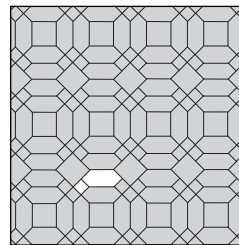

Georgian Parquet
 78.5 sf Symetry • 21.5 sf Squares

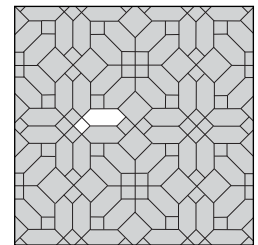

Palace Parquet
 83 sf Symetry • 17 sf Squares

PLAZA PAVERS™

Plaza Pavers™

12" x 12"

1 pc/sf • 108 sf/cube

8" x 8"

2.25 pcs/sf • 96 sf/cube

4" x 8"

4.5 pcs/sf • 108 sf/cube

All Plaza Pavers are 6 cm thick.

Our modular Plaza Pavers are perfect for creating elegant and distinctive larger-scale pavement designs.

Coverage based on 100 square feet of pavement.



MILLSTONE™

Large Rectangle

6 5/16" x 9 7/16" • 2.42 pcs/sf • 112 sf/cube

Medium Rectangle

4 3/4" x 6 5/16" • 4.84 pcs/sf • 91 sf/cube

Small Rectangle

3 1/8" x 6 5/16" • 7.24 pcs/sf • 96 sf/cube

Square Stone

6 5/16" x 6 5/16" • 3.62 pcs/sf • 104 sf/cube

Grand Square Stone

9 7/16" x 9 7/16" • 1.61 pcs/sf • 112 sf/cube



All MillStone pavers are 6 cm thick. MillStone can be laid in the same patterns as Yankee Cobble on the following page, including circles. The patterns shown below feature the Grand Square.

Coverage based on 100 square feet of pavement.

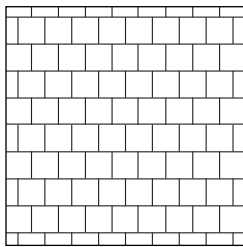

8 x 8 Running Bond
100 sf 8 x 8

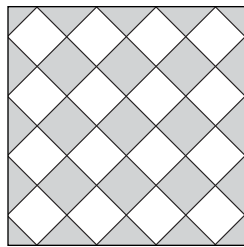

45° 12 x 12 Stack
100 sf 12 x 12

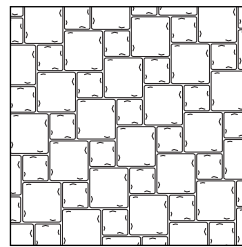

GS Pattern 1
69 sf Grand Squares
31 sf Squares

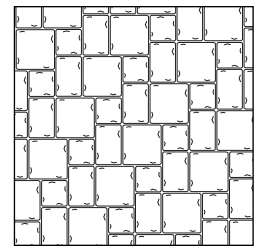

GS Pattern 2
47 sf Grand Sq. • 21 sf Squares
32 sf Lg. Rectangles

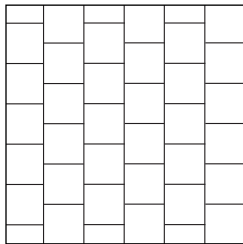

12 x 12 Running Bond
100 sf 12 x 12

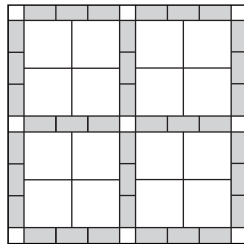

Pattern C
69 sf 12 x 12 • 29 sf 4 x 8
2 sf 4 x 4

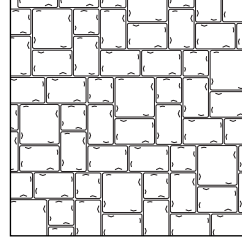

GS Pattern 4
19 sf Grand Sq. • 17 sf Squares
64 sf Lg. Rectangles

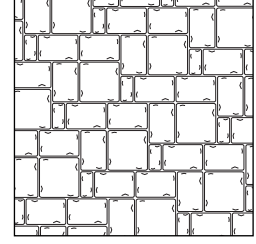

GS Pattern 6
31 sf Grand Sq. • 62 sf Lg. Rect.
7 sf Sm. Rectangles

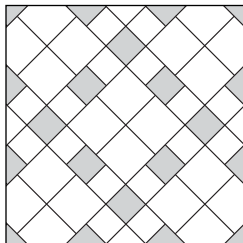

45° Pattern D
45 sf 12 x 12 • 55 sf 8 x 8

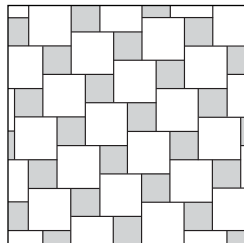

Pattern E
69 sf 12 x 12 • 31 sf 8 x 8

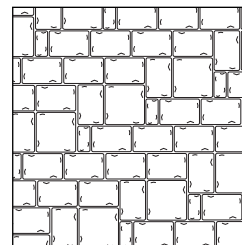

GS Pattern 7
22 sf Grand Sq. • 73 sf Lg. Rect.
5 sf Sm. Rectangles

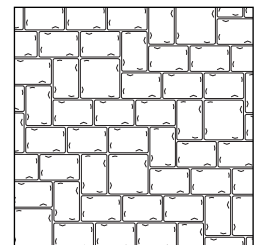

GS Pattern 9
43 sf Grand Squares
57 sf Lg. Rectangles

YANKEE COBBLE™

Large Rectangle

6 5/16" x 9 7/16" • 2.42 pcs/sf • 112 sf/cube

Medium Rectangle

4 3/4" x 6 5/16" • 4.84 pcs/sf • 91 sf/cube

Small Rectangle

3 1/8" x 6 5/16" • 7.24 pcs/sf • 96 sf/cube

Square Stone

6 5/16" x 6 5/16" • 3.62 pcs/sf • 104 sf/cube



All Yankee Cobble pavers are 6 cm thick.

Coverage based on 100 square feet of pavement.

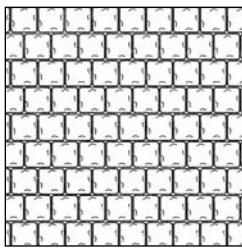

Pattern 1
100 sf Squares

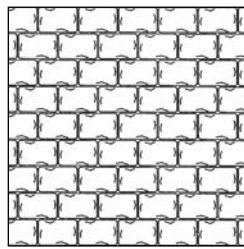

Pattern 2
100 sf Lg. Rectangles

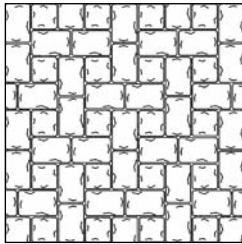

Pattern 6
27.5 sf Squares
72.5 sf Lg. Rectangles

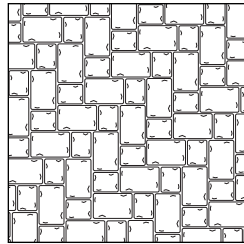

Pattern 19
33 sf Med. Rectangles
67 sf Lg. Rectangles

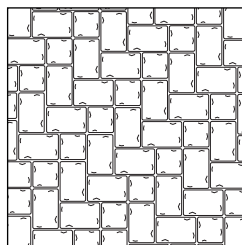

Pattern 20
25 sf Squares
75 sf Lg. Rectangles

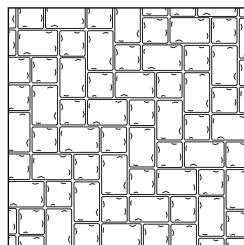

Pattern 21
40 sf Squares
60 sf Lg. Rectangles

Yankee Cobble™ & MillStone™ Circles

Packaged as follows:

- 6 - Center Stone
- 18 - Large Wedge Stone
- 174 - Small Wedge Stone
- 120 - Medium Rectangle
- 6 - Small Rectangle
- 64 sf/cube

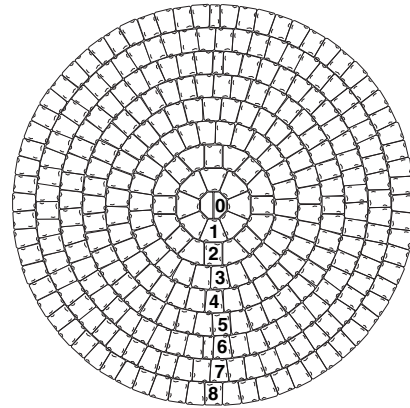

LEGEND			
CS	- Center Stone	MR	- Medium Rectangle
LW	- Large Wedge	SR	- Small Rectangle
SW	- Small Wedge		

Row	Diameter	CS	LW	SW	MR	SR	#Packages
0	6 1/4"	2					1st Circle Pak
1	19 1/4"		8				
2	31 3/4"		8		8		
3	44 1/2"			26			
4	57 1/2"			34			
5	70"			21	21		
6	83"			26	24	2	
7	96"			30	30		
8	108 1/2"			34	33	1	2nd Circle Pak
9	120 3/4"			38	38		
10	133 1/2"			42	42		
11	146 1/4"			45	45		
12	159"			49	49		Medium Rectangle Package
13	171 3/4"				106		
14	184 1/2"				115		

The patterns shown above also are applicable to MillStone.

Use *Medium Rectangle* and/or *Square* stones to expand the circle beyond the 14 rows shown in chart. Additional rows will increase the diameter in increments of approximately 12 3/4".

UNI ECO-STONE®

4 1/2" x 9"
 8 cm thickness
 3.55 pcs/sf
 79 sf/cube



Uni Eco-Stone's unique shape provides the same surface appearance with all of the installation patterns.

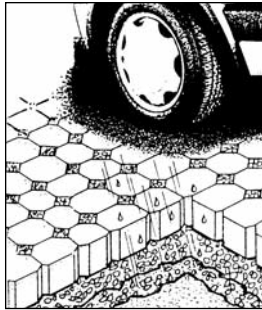

Drainage openings filled with aggregate allow rainwater to filter through to ground below

TURFSTONE™

23 5/8" x 15 3/4"
 8 cm thickness
 2.6 sf/pc
 146 sf/cube



Turfstone's openings can be planted with grass or filled with stone to help manage stormwater runoff.

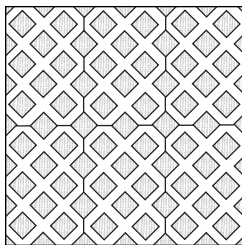

Stack Bond

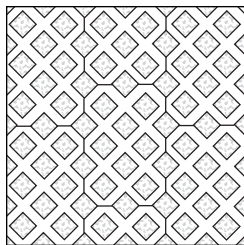

Running Bond 3/4 Offset

UNI-ANCHORLOCK®

8 7/8" x 8 7/8" - L-shaped
 8 cm thickness - *Made to order*
 2.41 pc/sf
 77.2 sf/cube



The interlocking design of Uni-Anchorlock is especially suited to vehicular traffic applications.

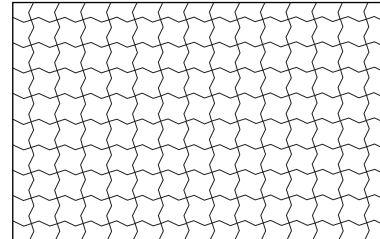

Z-STONE™

4 1/2" x 9"
 8 cm thickness - *Made to order*
 3.62 pc/sf
 99.5 sf/cube



Though Z-Stone provides outstanding performance for heavy-duty use, it also is an attractive pavement for residential applications.

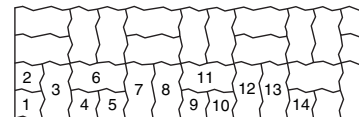

Basket Weave

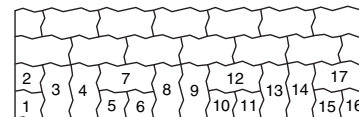

Running Bond

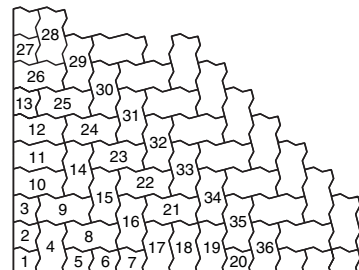

90° Herringbone

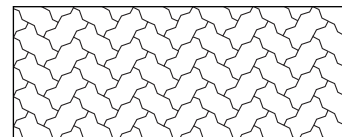

45° Herringbone

See page 12 for instructions on starting 45° herringbone patterns

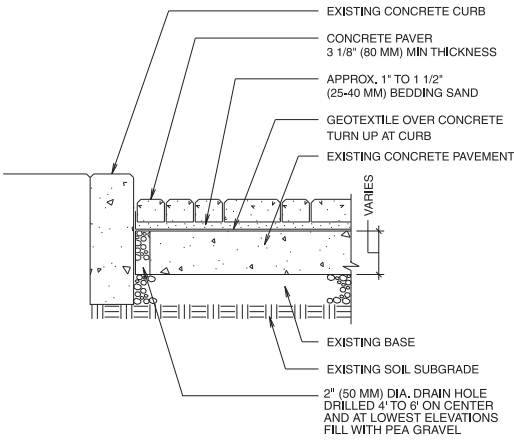

ICPI-02 - Street/Parking - Overlay on Existing Concrete Pavement

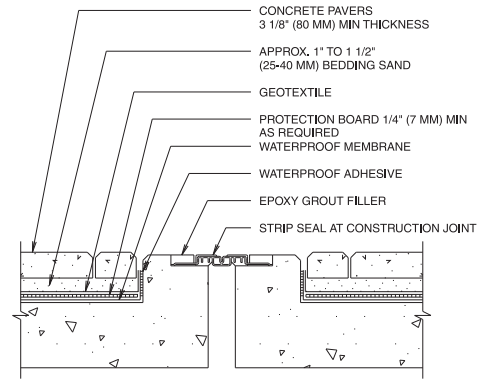

ICPI-05 - Parking Garage Over Uninhabited Space - Expansion Joint

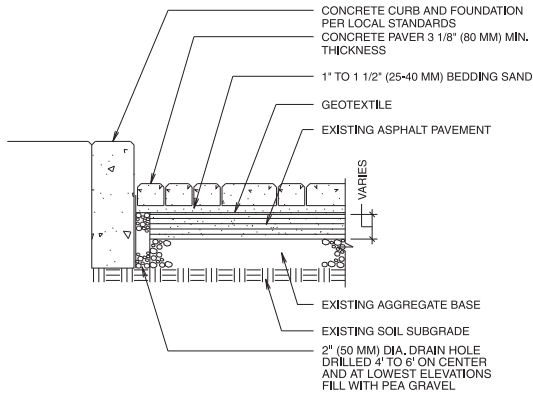

NOTE: DRAIN BEDDING SAND OF EXCESS MOISTURE THROUGH PAVEMENT AT LOWEST POINTS AS SHOWN OR AT CATCH BASIN(S).

ICPI-03 - Street/Parking - Overlay on Existing Asphalt Pavement

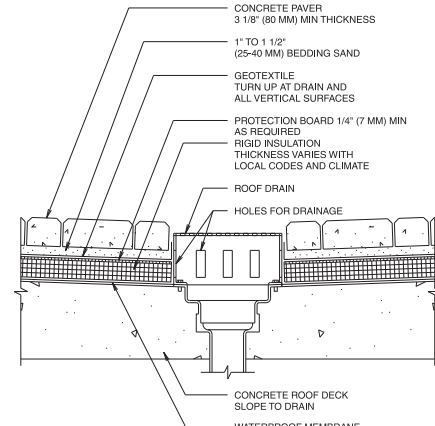

NOTES:
 1. PROTECTION BOARD AND INSULATION MUST WITHSTAND STATIC AND DYNAMIC VEHICULAR LOADS.
 2. INSULATION MAY BE EXCLUDED FOR SOME APPLICATIONS OVER UNINHABITED SPACE.

ICPI-06 - Parking Garage Over Inhabited/Uninhabited Space - Drain

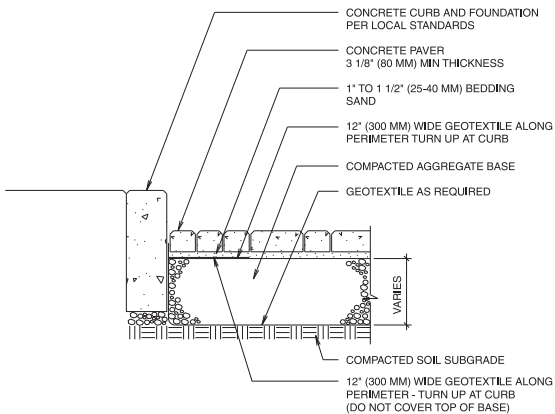

NOTES:
 1. DRAIN MAY BE NECESSARY IN SLOW DRAINING SUBGRADE.
 2. BASE THICKNESS VARIES WITH TRAFFIC, CLIMATE, AND SUBGRADE CONDITIONS. COLDER CLIMATES AND WEAK SOILS MAY REQUIRE THICKER BASES. CONSULT ICPI TECH SPEC 4 TO DETERMINE BASE THICKNESS.
 3. CONSULT ICPI TECH SPEC 2 AND CSI MANU SPEC FOR GUIDELINES AND SPECIFICATIONS FOR BASE MATERIALS, SUBGRADE SOIL AND BASE COMPACTION.
 4. DO NOT COVER ENTIRE TOP OF AGGREGATE BASE WITH GEOTEXTILE.

ICPI-04 - Street/Parking - Compacted Aggregate Base

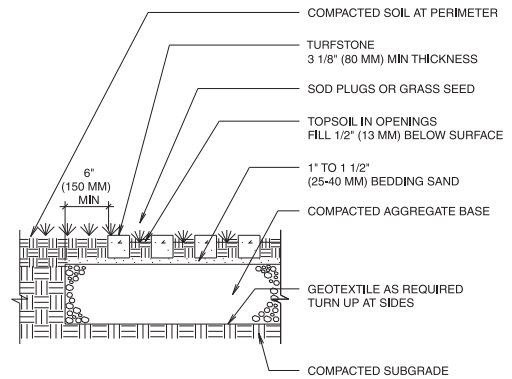

NOTE: 1. BASE THICKNESS VARIES WITH TRAFFIC, CLIMATE, AND SUBGRADE.
 2. MINIMUM BASE THICKNESS: 6" (150 MM) RESIDENTIAL DRIVEWAYS, 8" FIRELANES & PARKING LOTS.

ICPI-08 - Fire Lane, Driveway, Intermittent Parking - Turfstone Grid Pavers

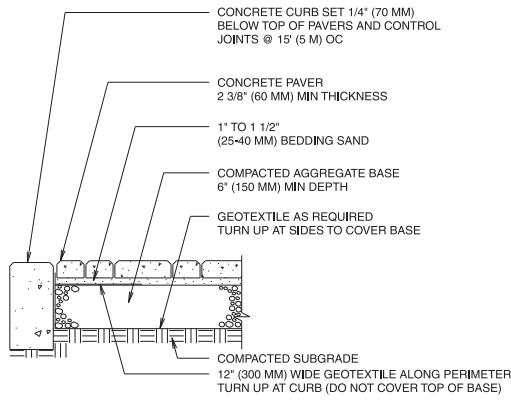

- NOTES:
1. THICKNESS OF AGGREGATE BASE WILL VARY WITH SUBGRADE CONDITIONS AND CLIMATE. COLDER CLIMATES MAY REQUIRE THICKER BASES.
 2. CONCRETE PAVERS SHOULD BE PLACED ON A CEMENT TREATED BASE IF SOIL IS EXTREMELY WEAK OR CONSTANTLY SATURATED. PAVERS CAN BE OVERLAID OR INLAID ON EXISTING ASPHALT OR CONCRETE DRIVEWAYS.
 3. CONSULT ICPI TECH SPEC 2 FOR GUIDELINES ON SPECIFICATIONS FOR BASE MATERIALS, SUBGRADE SOIL AND BASE COMPACTION.
 4. PLASTIC, STEEL, ALUMINUM OR PRECAST CONCRETE, EDGING MAY BE USED.

ICPI-09 - Residential Driveway with Concrete Edges

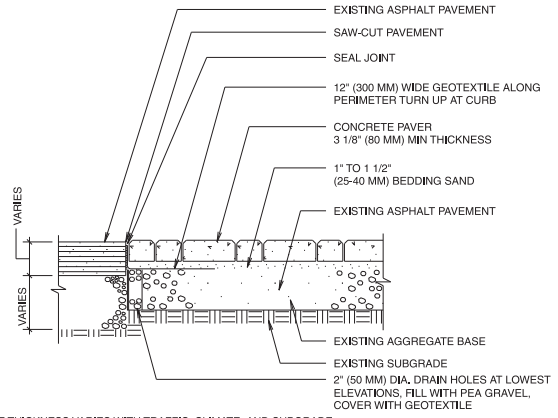

- NOTES:
1. BASE THICKNESS VARIES WITH TRAFFIC, CLIMATE, AND SUBGRADE. COLDER CLIMATES AND WEAK SOIL MAY REQUIRE THICKER BASES.
 2. BOTTOM ELEVATION OF EXISTING ASPHALT PAVEMENT MUST BE BELOW BEDDING SAND.
 3. CONCRETE BEAMS AT ENDS OF PAVEMENT MAY BE NECESSARY IF ASPHALT IS SUBJECT TO RUTTING.
 4. DO NOT USE DRAIN HOLES TO SUBGRADE WHEN WATER TABLE IS LESS THAN 2' (0.6 M) FROM TOP OF SUBGRADE. DRAIN TO CATCH BASINS.

ICPI-13 - Cross Walk on Cement or Asphalt-Treated Base

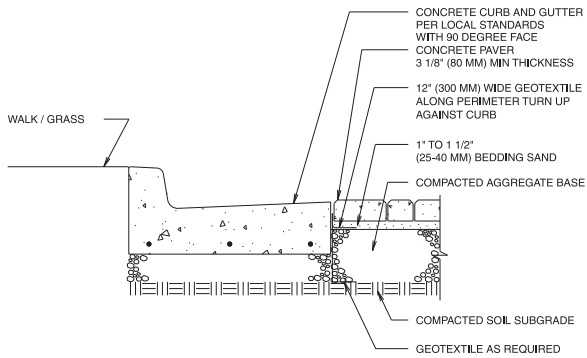

NOTE: DRAIN MAY BE NECESSARY IN SOIL SUBGRADE.

ICPI-10 - Concrete Curb and Gutter with Concrete Pavers

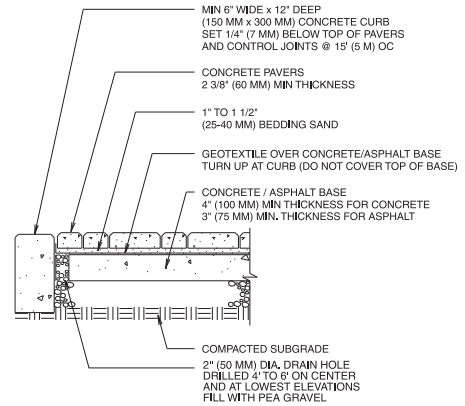

- NOTE:
1. THICKNESS OF BASE WILL VARY WITH SUBGRADE CONDITIONS AND CLIMATE. COLDER CLIMATES MAY REQUIRE THICKER BASES.
 2. CONSULT ICPI TECH SPEC 2 AND CSI MANU SPEC FOR GUIDELINES ON SPECIFICATIONS FOR BASE MATERIALS, SUBGRADE SOIL AND BASE COMPACTION.

ICPI-14 - Patio, Sidewalk, or Plaza on Concrete or Asphalt Base

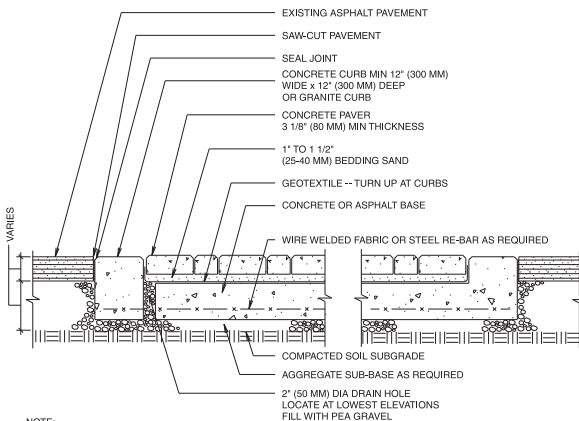

- NOTE:
1. BASE THICKNESS AND REINFORCING VARIES WITH TRAFFIC, CLIMATE, AND SUBGRADE CONDITIONS.
 2. CONCRETE BASE MINIMUM 2% SLOPE FROM CENTERLINE TO CURBS.
 3. DO NOT USE DRAIN HOLES TO SUBGRADE WHEN WATER TABLE IS LESS THAN 2' (0.6 M) FROM TOP OF SUBGRADE. DRAIN TO CATCH BASINS.

ICPI-12 - Cross Walk on Concrete or Asphalt Base

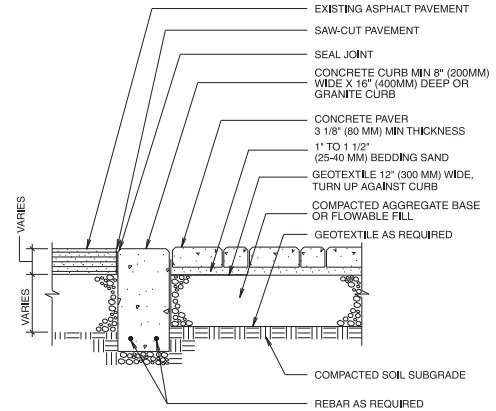

- NOTE:
1. BASE THICKNESS VARIES WITH TRAFFIC, CLIMATE, AND SUBGRADE CONDITIONS.
 2. CONCRETE CURBS DO NOT DEFLECT TO THE SAME DEPTH AS PAVERS OR EXISTING ASPHALT. THIS DETAIL IS NOT RECOMMENDED FOR OTHER THAN LOW VOLUME RESIDENTIAL STREETS.
 3. THICKENING ASPHALT PAVEMENT ADJACENT TO CONCRETE CURB IS RECOMMENDED.

ICPI-15 - Cross Walk on Compacted Aggregate/Flowable Fill Base

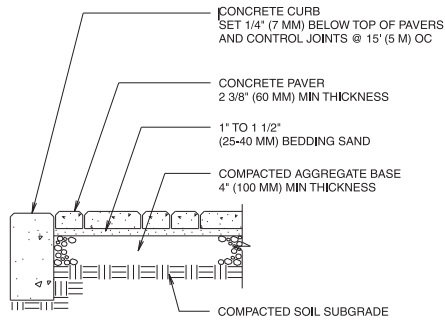

- NOTE:
1. THICKNESS OF BASE WILL VARY WITH SUBGRADE CONDITIONS AND CLIMATE. COLDER CLIMATES MAY REQUIRE THICKER BASES.
 2. CONSULT ICPI TECH SPEC 2 FOR GUIDELINES ON SPECIFICATIONS FOR BASE MATERIALS, SUBGRADE SOIL AND BASE COMPACTION.

ICPI-16 - Patio, Sidewalk, or Plaza on Compacted Aggregate Base

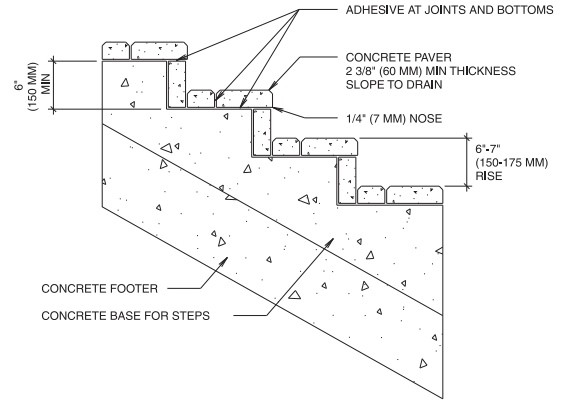

NOTE: USE OF MORTAR IS NOT RECOMMENDED EXCEPT IN NON-FREEZE-THAW AREAS.

ICPI-19 - Steps with Concrete Pavers

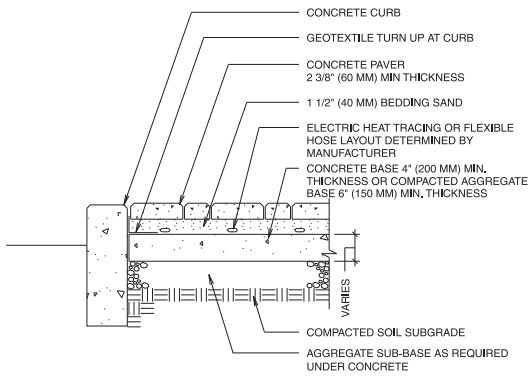

- NOTES:
1. HEATED ASSEMBLIES CAN BE PLACED ON A CEMENT TREATED BASE OR COMPACTED AGGREGATE. A CONCRETE BASE HAS THE HIGHEST THERMAL EFFICIENCY.
 2. ON CONCRETE BASE, PROVIDE PEA GRAVEL-FILLED WEEP HOLE(S) AT LOWEST POINT(S). COVER TOP OF HOLE WITH GEOTEXTILE.
 3. ON AN AGGREGATE BASE, GEOTEXTILE IS ONLY REQUIRED ALONG THE CURB.
 4. FLEXIBLE HOSE CAN BE PLACED IN TOP LAYER OF AGGREGATE BASE PRIOR TO BASE COMPACTION.

ICPI-17 - Heated Sidewalk or Driveway

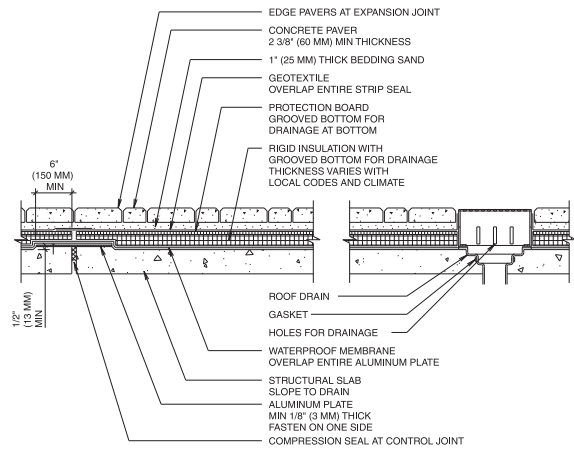

- NOTE: 1. CHECK WITH LOCAL WIND CODES FOR BALLAST REQUIREMENTS.
2. PROTECTION BOARD AND INSULATION MUST WITHSTAND STATIC AND DYNAMIC LOADS.

ICPI-20 - Roof Deck over Habitable Space

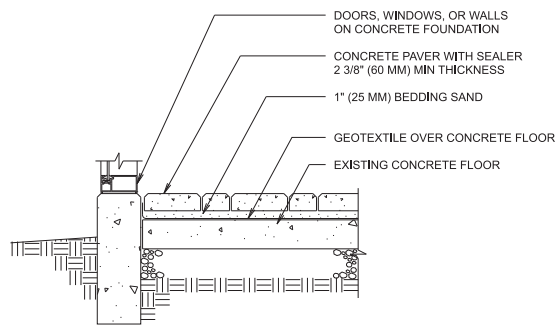

ICPI-18 - Interior with Concrete Base

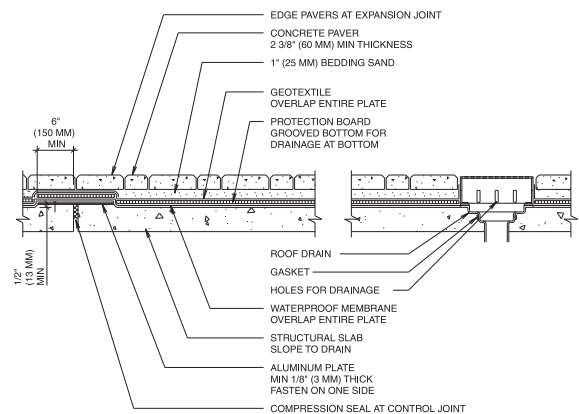

- NOTE: 1. CHECK WITH LOCAL WIND CODES FOR BALLAST REQUIREMENTS.
2. PROTECTION BOARD MUST WITHSTAND STATIC AND DYNAMIC LOADS.

ICPI-21 - Roof Deck over Uninhabited Space

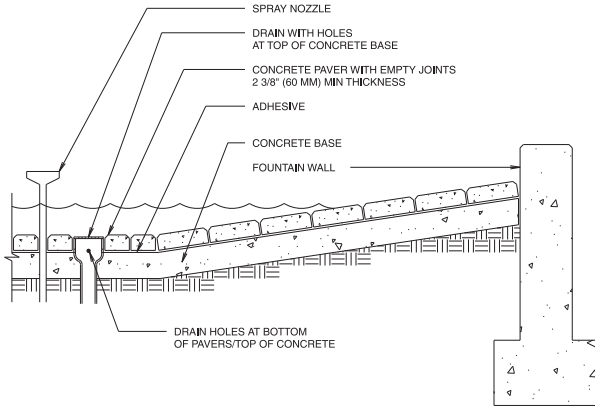

NOTE: PAVERS CAN BE LAID WITHOUT ADHESIVE.

ICPI-22 - Fountain Detail

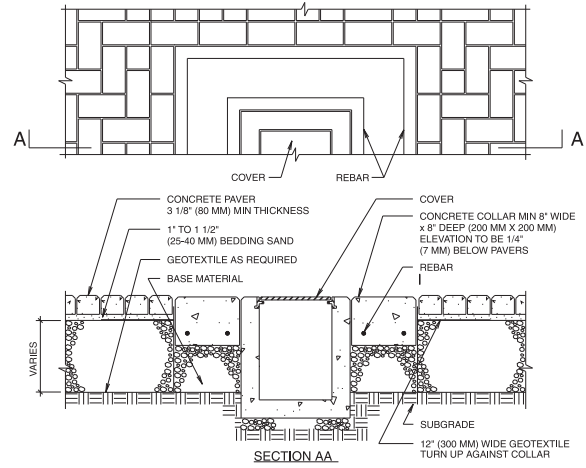

ICPI-25 - Utility Structure - Valve Box, Pull Box, or Lamp Hole

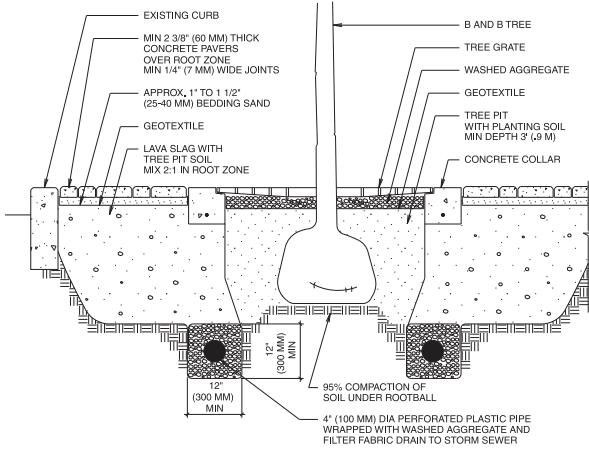

ICPI-23 - Tree Pit with Non-Compacted Root Zone Under Pavers

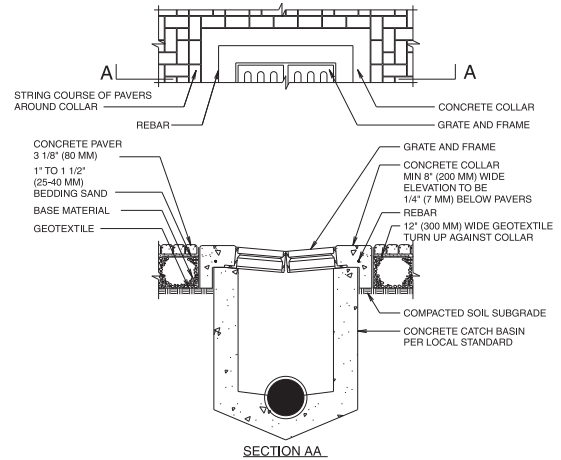

NOTE: SIZE AND REINFORCING OF CONCRETE VARIES WITH TRAFFIC.

ICPI-26 - Catch Basin

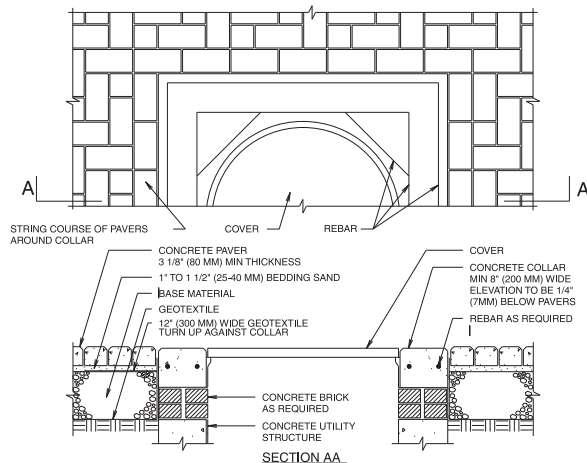

ICPI-24 - Utility Structure - Manhole

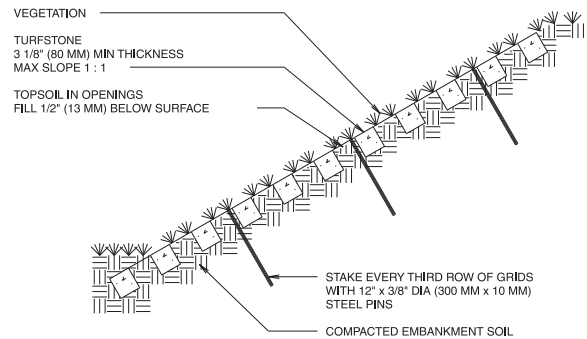

ICPI-28 - Slope Protection - Turfstone Grid Pavers

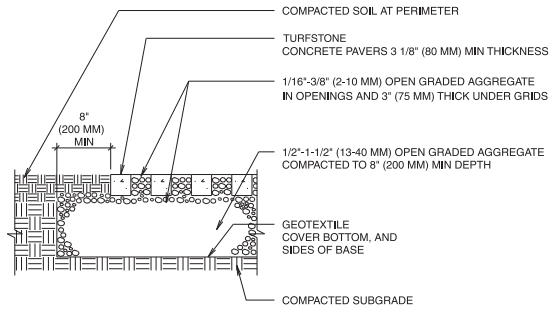

- NOTES:
1. DEPTH OF OPEN GRADED BASE WILL EFFECT RUNOFF STORAGE CAPACITY
 2. BEARING CAPACITY AND PERMEABILITY OF SOIL SUBGRADE SHOULD BE EVALUATED FOR SUITABILITY WITH APPLICATION, TRAFFIC & STORM WATER MANAGEMENT CRITERIA, DRAINAGE OF SUBGRADE MAY BE REQUIRED.
 3. IF TOPSOIL IS PLACED IN OPENINGS THEN USE 1" TO 1-1/2" (25-40 MM) BEDDING UNDER GRID PAVERS OVER GEOTEXTILE.
 4. EDGE RESTRAINTS REQUIRED

ICPI-29 - Turfstone Grid Pavers for Stormwater Runoff Control

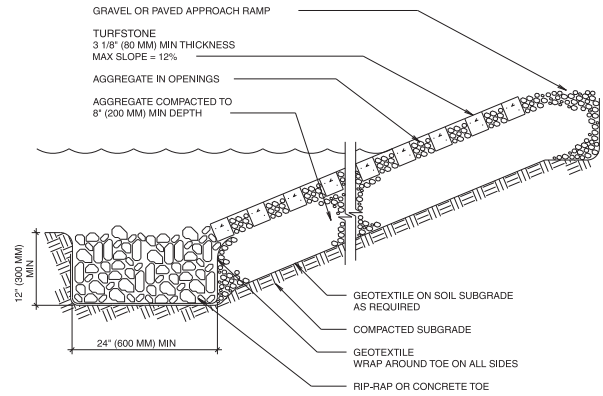

NOTE: USE FOR NON-TIDAL FRESHWATER APPLICATIONS.

ICPI-32 - Boat Ramp - Turfstone Grid Pavers

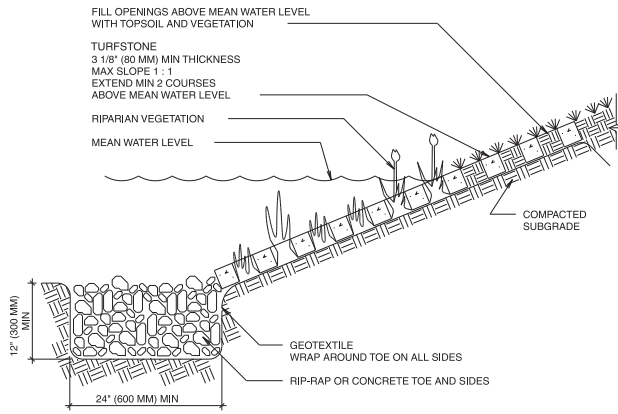

ICPI-30 - Riparian Stabilization - Turfstone Grid Pavers for Stream Banks and Lake Slides

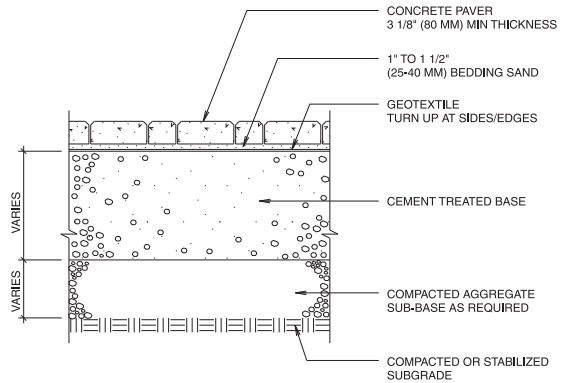

NOTE: BASE, SUB-BASE, AND SUBGRADE THICKNESS VARY WITH LOADS, SUBGRADE STRENGTH, AND CLIMATE.

ICPI-33 - Port / Industrial Pavement with Cement-Treated Base

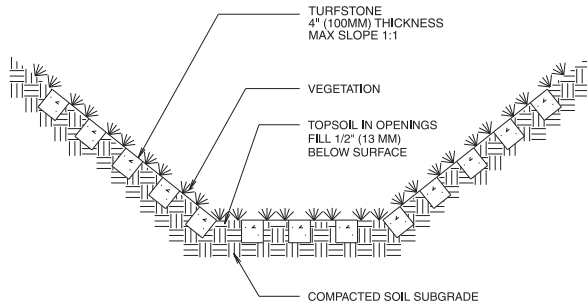

NOTE: AGGREGATE MAY BE USED IN OPENINGS OF GRID PAVERS.

ICPI-31 - Ditch Liner for Intermittent Flows - Turfstone Grid Pavers

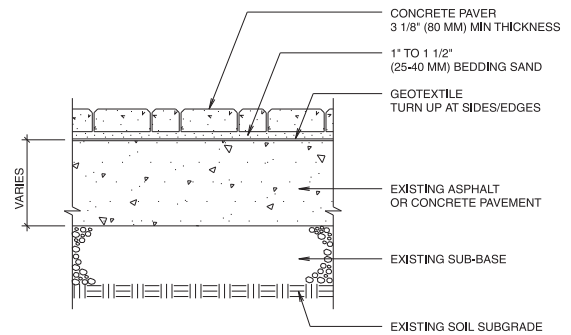

- NOTE:
1. EXISTING ASPHALT OR CONCRETE PAVEMENT SHALL BE THOROUGHLY INSPECTED FOR AREAS IN NEED OF PATCHING OR REPLACEMENT. CONDUCT ALL REPAIRS AND FILL ALL CRACKS GREATER THAN 1/4" (7 MM) WIDE PRIOR TO PLACING GEOTEXTILE, SAND, AND PAVERS.
 2. PROVIDE DRAINAGE OF SAND LAYER THROUGH 2" (50 MM) DIA. DRAIN HOLES DRILLED 4" TO 6" ON CENTER AND AT LOWEST ELEVATIONS FILL WITH PEA GRAVEL OR UTILIZE CATCH BASINS

ICPI-34 - Port / Industrial Pavement on Existing Asphalt / Concrete

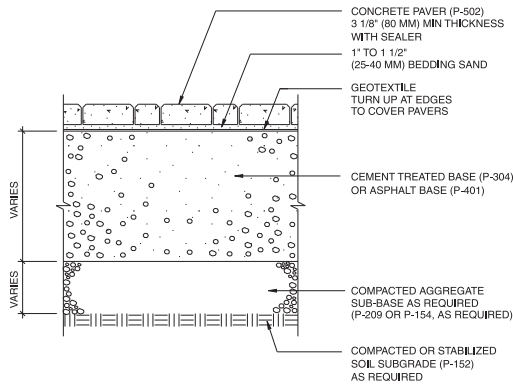

NOTE: BASE, SUB-BASE, AND SUBGRADE THICKNESS VARY WITH LOADS, SOIL STRENGTH, AND CLIMATE.

ICPI-35 - Airfield Pavement with Cement or Asphalt-Treated Base

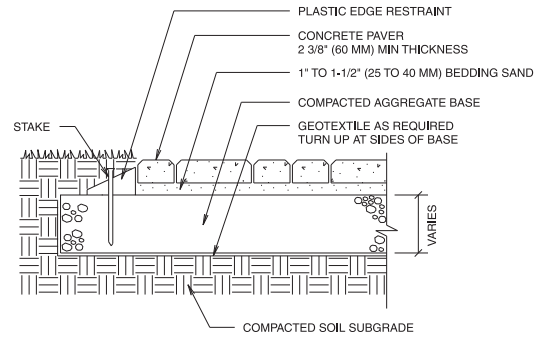

NOTE:
1. THICKNESS OF AGGREGATE BASE WILL VARY WITH SUBGRADE CONDITIONS AND CLIMATE. COLDER CLIMATES MAY REQUIRE THICKER BASES.

ICPI-52 - Patio, Walkway, or Driveway with Plastic Edge Restraint

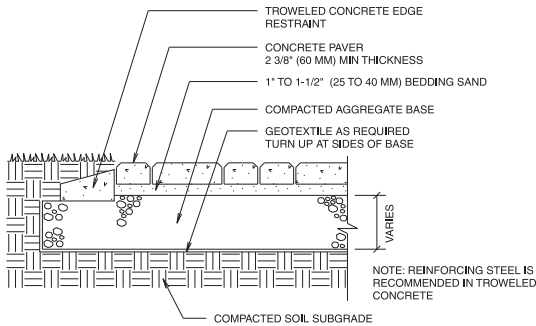

NOTE:
1. USE 5:1 (AGGREGATE-CEMENT) MIX FOR CONCRETE EDGE.
2. RECOMMENDED FOR NON-FREEZE THAW AREAS.
3. CONSTRUCTION OF THIS DETAIL CAN BE USED ON RESIDENTIAL DRIVEWAYS IN NON-FREEZE THAW AREAS. REINFORCING MAY BE REQUIRED IN THE EDGE RESTRAINT.
4. THICKNESS OF AGGREGATE BASE WILL VARY WITH SUBGRADE CONDITIONS AND CLIMATE. COLDER CLIMATES MAY REQUIRE THICKER BASES.

ICPI-50 - Patio, Walkway, or Driveway with Troweled Concrete Edge

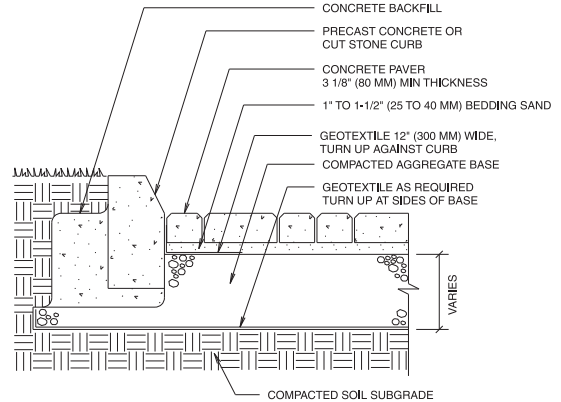

NOTE:
1. THICKNESS OF AGGREGATE BASE WILL VARY WITH SUBGRADE CONDITIONS AND CLIMATE. COLDER CLIMATES MAY REQUIRE THICKER BASES.

ICPI-56 - Patio, Walkway, or Driveway with Precast Concrete or Cut-Stone Curb

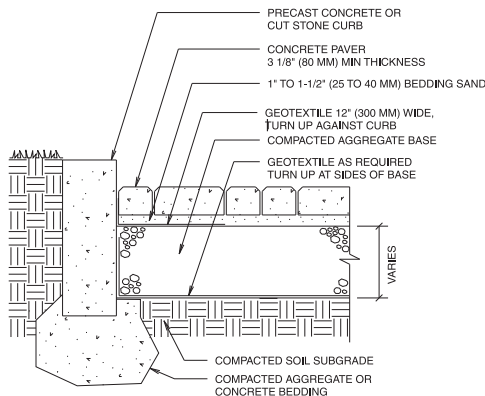

NOTE:
1. EDGE RESTRAINT SHOULD BE MINIMUM 6\"/>

ICPI-51 - Street Pavement - Full-Depth Precast Concrete or Cut Stone Curb

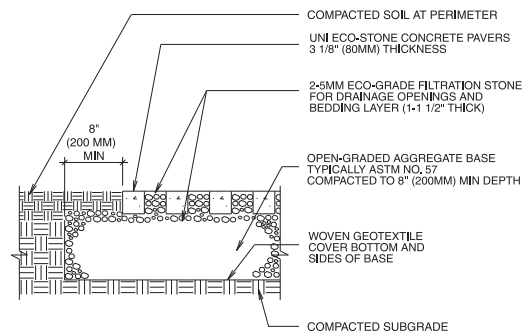

NOTES:
1. DEPTH OF OPEN GRADED BASE WILL EFFECT RUNOFF STORAGE CAPACITY
2. BEARING CAPACITY AND PERMEABILITY OF SOIL SUBGRADE SHOULD BE EVALUATED FOR SUITABILITY WITH APPLICATION, TRAFFIC & STORM WATER MANAGEMENT CRITERIA. DRAINAGE OF SUBGRADE MAY BE REQUIRED.
3. EDGE RESTRAINTS REQUIRED

UNIECO-1 - Uni Eco-Stone® Pavers for Stormwater Runoff Control

NOTES

Pavers by Ideal®

Pavers

- Boston Colonial Pavers®
- Georgetown Colonial Pavers™
- Yankee Cobble™
- MillStone™
- Plaza Pavers™
- Symetry®
- Turfstone™
- CurbStone
- Uni-Decor®
- Z-Stone™
- Uni-Anchorlock®
- Uni Eco-Stone®
- BullNose Coping

Walls

- Pisa2®
- Roman Pisa®
- Stonewall™
- Tumbled Stonewall® SF
- GravityStone®
- Tumbled Scapestone™
- Universal Coping Stone™
- ReversaCap®
- Roman Pisa® Coping

Accessories

- Kerr Paver & Wall Lights
- Pisa Lite™ & Pisa Sounds™
- PaveEdge®
- SandLock™
- SRW® Paver & Wall Adhesive
- Paver & Wall Splitters
- The Pounder®
- Cleaners & Sealers
- SRW® Geogrid
- Landscape Fabric
- Woven Geotextile



Boston Colonial Pavers®, *Georgetown Colonial Pavers™*, *Yankee Cobble™*, *MillStone™* and *Tumbled ScapeStone™* are trademarks of *Ideal Concrete Block Company, Inc.*

Ideal is contracted to produce a number of products under exclusive license agreements:

- *Uni-Decor®*, *Uni-Anchorlock®*, *Eco-Stone®* are registered trademarks of and are licensed exclusively by *F. von Langsdorff Lic. Ltd.*
- *Symetry®* is a registered trademark of *Symrah Licensing, Inc.*
- *Pisa2®*, *Roman Pisa®* and *ReversaCap®* are registered trademarks of *Risi Stone Systems.*
- *Stonewall™* and *GravityStone®* are registered trademarks of *Westblock Products, Inc.*
- *Pave-Edge®* is a registered trademark of *Pave Tech, Inc.*

DISCLAIMER

To the best of our knowledge, the information contained in this guide is accurate. *Ideal* cannot assume liability whatsoever for the accuracy or completeness thereof nor do we guaranty or warrant the recommendations contained herein. A qualified engineer who is familiar with the conditions of a particular site and with the local construction practices should be consulted for guidance with design and construction recommendations. Final determination of the suitability of any information provided in this guide or of material, its manner or use, is the sole responsibility of the user.



Ideal Concrete Block Company, Inc.

45 Power Road, Westford, MA 01886
232 Lexington Street, Waltham, MA 02452
(781) 894-3200 • Westford Fax (978) 692-0817 • Waltham Fax (781) 894-8526
www.IdealConcreteBlock.com